

## Touchstone® TM1602G Telephony Modem User's Guide



Get ready to experience the Internet's express lane! Whether you're checking out streaming media, downloading new software, checking your email, or talking with friends on the phone, the Touchstone TM1602G Telephony Modem brings it all to you faster and more reliably, all while providing toll quality Voice over IP telephone service. It also provides a Lithium-Ion battery backup to provide continued telephone service during power outages.

The Touchstone Telephony Modem provides an Ethernet connection for use with either a single computer or home/office Local Area Network (LAN). The Touchstone Telephony Modem provides for up to two separate lines of telephone service.

Installation is simple and your cable company will provide assistance to you for any special requirements. The links below provide more detailed instructions.

[Safety Requirements](#)

[Getting Started](#)

[Battery Installation](#)

[Installing and Connecting Your Telephony Modem](#)

[Configuring Your Ethernet Connection](#)

[Using the Telephony Modem](#)

[Troubleshooting](#)

[Glossary](#)

## **Export Regulations**

This product may not be exported outside the U.S. and Canada without U.S. Department of Commerce, Bureau of Export Administration authorization. Any export or re-export by the purchaser, directly or indirectly, in contravention of U.S. Export Administration Regulation is prohibited.

©ARRIS Enterprises, Inc. 2015 All rights reserved. No part of this publication may be reproduced in any form or by any means or used to make any derivative work (such as translation, transformation, or adaptation) without written permission from ARRIS Enterprises, Inc. ("ARRIS"). ARRIS reserves the right to revise this publication and to make changes in content from time to time without obligation on the part of ARRIS to provide notification of such revision or change.

ARRIS provides this guide without warranty of any kind, implied or expressed, including, but not limited to, the implied warranties of merchantability and fitness for a particular purpose. ARRIS may make improvements or changes in the product(s) described in this manual at any time. The capabilities, system requirements and/or compatibility with third-party products described herein are subject to change without notice.

ARRIS and the ARRIS logo are all trademarks of ARRIS Enterprises, Inc. Other trademarks and trade names may be used in this document to refer to either the entities claiming the marks and the names of their products. ARRIS disclaims proprietary interest in the marks and names of others.

Protected under one or more of the following U.S. patents: 7,031,435. Other patents pending.

Release 16 Standard 1.3 January 2015

## Safety Requirements

ARRIS Telephony Modems comply with the applicable requirements for performance, construction, labeling, and information when used as outlined below:



### **CAUTION** **Risk of shock**

Mains voltages inside this unit. No user serviceable parts inside. Refer service to qualified personnel only!

### **CAUTION** **Double pole/Neutral fusing**



### **CAUTION** **Potential equipment damage** **Potential loss of service**

Connecting the Telephony Modem to existing telephone wiring should only be performed by a professional installer. Physical connections to the previous telephone provider must be removed and the wiring must be checked; there must not be any voltages. Cancellation of telephone service is not adequate. Failure to do so may result in loss of service and/or permanent damage to the Telephony Modem.



### **CAUTION** **Risk of explosion**

Replacing the battery with an incorrect type, heating a battery above 75°C, or incinerating a battery, can cause product failure and a risk of fire or battery explosion. Do not disassemble. Do not dispose of in fire. Keep away from children. Recycle or dispose of used batteries responsibly and in accordance with local ordinances.

- The Telephony Modem is designed to be connected directly to a telephone.
- Connecting the Telephony Modem to the home's existing telephone wiring should only be performed by a professional installer.

- Do not use product near water (i.e. wet basement, bathtub, sink or near a swimming pool, etc.), to avoid risk of electrocution.
- Do not use the telephone to report a gas leak in the vicinity of the leak.
- Do not use spray cleaners or aerosols on the Telephony Modem.
- The product shall be cleaned using only a damp, lint-free, cloth. No solvents or cleaning agents shall be used.
- Avoid using and/or connecting the equipment during an electrical storm, to avoid risk of electrocution.
- Do not locate the equipment within 6 feet (1.9 m) of a flame or ignition source (i.e. heat registers, space heaters, fireplaces, etc.).
- Use only the AC power adapter (if provided) and power cord included with the equipment.
- Equipment should be installed near the power outlet and should be easily accessible.
- The shield of the coaxial cable must be connected to earth (grounded) at the entrance to the building in accordance with applicable national electrical installation codes. In the U.S., this is required by NFPA 70 (National Electrical Code) Article 820. In the European Union and in certain other countries, CATV installation equipotential bonding requirements are specified in IEC 60728-11, *Cable networks for television signals, sound signals and interactive services, Part 11: Safety*. This equipment is intended to be installed in accordance with the requirements of IEC 60728-11 for safe operation.  
  
If the equipment is to be installed in an area serviced by an IT power line network, as is found in many areas of Norway, special attention should be given that the installation is in accordance with IEC 60728-11, in particular Annex B and Figure B.4.
- In areas of high surge events or poor grounding situations and areas prone to lightning strikes, additional surge protection may be required (i.e. PF11VNT3 from American Power Conversion) on the AC, RF, Ethernet and Phone lines.
- When the Telephony Modem is connected to a local computer through Ethernet cables, the computer must be properly grounded to the building/residence AC ground network. All plug-in cards within the computer must be

- Ensure proper ventilation. Position the Telephony Modem so that air flows freely around it and the ventilation holes on the unit are not blocked.
- Do not mount the Telephony Modem on surfaces that are sensitive to heat and/or which may be damaged by the heat generated by the modem, its power supply, or other accessories.

## FCC Part 15

This equipment has been tested and found to comply with the requirements for a Class B digital device under Part 15 of the Federal Communications Commission (FCC) rules. These requirements are intended to provide reasonable protection against harmful interference in a residential installation. This equipment generates, uses and can radiate radio frequency energy and, if not installed and used in accordance with the instructions, may cause harmful interference to radio communications. However, there is no guarantee that interference will not occur in a particular installation. If this equipment does cause harmful interference to radio or television reception, which can be determined by turning the equipment off and on, the user is encouraged to try to correct the interference by one or more of the following measures:

- Reorient or relocate the receiving antenna.
- Increase the separation between the equipment and receiver.
- Connect the equipment into an outlet on a circuit different from that to which the receiver is connected.
- Consult the dealer or an experienced radio/TV technician for help.

Changes or modifications to this equipment not expressly approved by the party responsible for compliance could void the user's authority to operate the equipment.

**Warning:** Changes or modifications to this equipment not expressly approved by the party responsible for compliance could void the user's authority to operate the equipment.

### **RF Exposure**

This equipment complies with FCC radiation exposure limits set forth for an uncontrolled environment. This equipment should be installed and operated with minimum distance of 7.9 inches (20cm) between the radiator and your body. This transmitter must not be co-located or operating in conjunction with any other antenna or transmitter.

### **Industry Canada Compliance**

Under Industry Canada regulations, this radio transmitter may only operate using an antenna of a type and maximum (or lesser) gain approved for the transmitter by Industry Canada. To reduce potential radio interference to other users, the antenna type and its gain should be so chosen that the equivalent isotropically radiated power (e.i.r.p.) is not more than that necessary for successful communication.

This device complies with Industry Canada license-exempt RSS standard(s). Operation is subject to the following two conditions: (1) this device may not cause interference, and (2) this device must accept any interference, including interference that may cause undesired operation of the device.

### **For Mexico**

The operation of this equipment is subject to the following two conditions: (1) This equipment or device cannot cause harmful interference and (2) this equipment or device must accept any interference, including interference that may cause some unwanted operation of the equipment.

properly installed and grounded to the computer frame per the manufacturer's specifications.

## European Compliance

This product complies with the provisions of the Electromagnetic Compatibility (EMC) Directive (89/336/EEC), the Amending Directive (92/31/EEC), the Low Voltage Directive (73/23/EEC), and the CE Marking Directive (93/68/EEC). As such, this product bears the CE marking in accordance with the above applicable Directive(s).

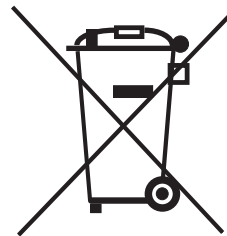

A copy of the Declaration of Conformity may be obtained from: ARRIS International, Inc., 3871 Lakefield Drive, Suite 300, Suwanee, GA 30024.

As indicated by this symbol, disposal of this product is governed by Directive 2002/96/EC of the European Parliament and of the Council on waste electrical and electronic equipment (WEEE). WEEE could potentially prove harmful to the environment; as such, upon disposal of the Telephony Modem the Directive requires that this product must not be disposed as unsorted municipal waste, but rather collected separately and disposed of in

accordance with local WEEE ordinances.

**ARRIS** This product complies with directive 2002/95/EC of the European Parliament and of the Council of 27 January 2003 on the restriction of the use of certain hazardous substances (RoHS) in electrical and electronic equipment.

RoHS Compliant

GREEN

## Getting Started

### About Your New Telephony Modem

The Touchstone TM1602G Telephony Modem is DOCSIS® compliant with the following features:

- Speed: much faster than dialup or ISDN service; up to sixteen times faster than DOCSIS 2.0 cable modems
- Connectivity: supports Ethernet connection
- Flexibility: provides two independent lines of telephone service as well as high speed data
- Compatibility:
  - Data services: DOCSIS 3.0 compliant and backward-compatible with DOCSIS 2.0 or 1.1; supports tiered data services (if offered by your cable company)
  - Telephony services: PacketCable™ 2.0, 1.5, or 1.0 compliant

### What's in the Box?

Make sure you have the following items before proceeding. Call your cable company for assistance if anything is missing.

- Telephony Modem
- Power Cord
- Battery (not included with all models)
- Ethernet Cable (CAT5e)
- End User License Agreement



## Items You Need

If you are installing the Telephony Modem yourself, make sure you have the following items on hand before continuing:

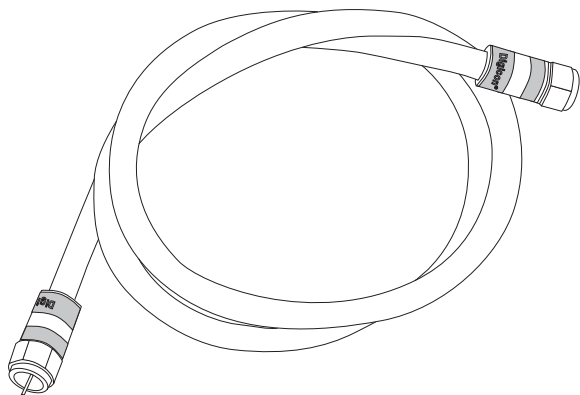

**Coax Cable**

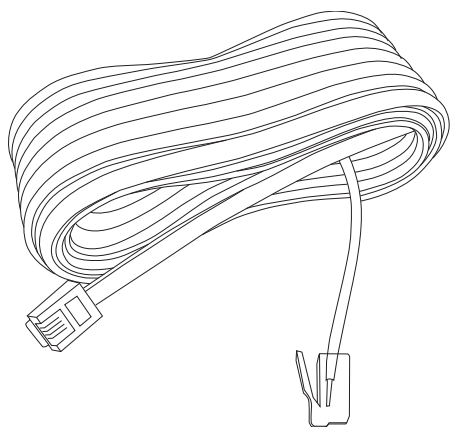

**Phone Cable**

- **Telephony modem package:** see What's in the Box? for a list of items in the package.
  - **Coaxial cable (coax):** as shown in the image to the left, this is a round cable with a connector on each end. It is the same kind of wire used to connect to your television for cable TV. You can buy coax from any electronics retailer and many discount stores; make sure it has connectors on both ends. There are two types of connectors, slip-on and screw-on; the screw-on connectors are best for use with your Telephony Modem. The coax should be long enough to reach from your Telephony Modem to the nearest cable outlet.
- Note:** For best performance, use high-quality RG-6 type coax cable and minimize or eliminate splitters between the cable jack and the Telephony Modem.
- **Phone Cable:** as shown in the image to the left, this is a standard phone cable with standard phone connectors (RJ11 type) on both ends. You can buy phone cables from any electronics retailer and many discount stores.
  - **Splitter (optional):** provides an extra cable connection by splitting a single outlet into two. You may need a splitter if you have a TV already connected to the cable outlet that you want to use. You can buy a splitter from any electronics retailer and most discount stores; you may also need a short piece of coax cable (with connectors); use it to connect the splitter to the cable outlet and then connect the Telephony Modem and TV to the splitter.
- Note:** A splitter effectively cuts the signal in half and sends each half to its two outputs. Using several splitters in a line may deteriorate the quality of your television, telephone, and/or internet connection.
- **Wall-mount hardware (optional):** if you want to wall-mount your Telephony Modem, you need to obtain two drywall anchors or wood screws. See the Wall-Mount Template and Instructions for more details.
  - **Information packet:** your cable company should furnish you with a packet containing information about your service and how to set it up. Read this information carefully and contact your cable company if you have any questions.

## Getting Service

Before trying to use your new Telephony Modem, contact your local cable company to establish an Internet account and telephone service. When you call, have the following information ready:

- the Telephony Modem serial number and MAC addresses of the unit (printed on a sticker on the bottom of the Telephony Modem)
- the model number of the Telephony Modem

Save this information for future use. In addition, you should ask your cable company the following questions:

- Do you have any special system requirements or files that I need to download after I am connected?
- When can I start using my Telephony Modem?
- Do I need a user ID or password to access the Internet or my e-mail?
- Will my phone number(s) change?
- What new calling features will I have and how do I use them?

## System Requirements

The Touchstone Telephony Modem operates with most computers. The following describes requirements for each operating system; see the documentation for your system for details on enabling and configuring networking.

To use the Telephony Modem, you need DOCSIS high-speed Internet service from your cable company. Telephone service requires that the cable company has Packet-Cable support.

### Recommended Hardware

The following hardware configuration is recommended. Computers not meeting this configuration can still work with the TM1602G, but may not be able to make maximum use of TM1602G throughput.

- CPU: P4, 3GHz or faster
- RAM: 1GB or greater
- Hard drive: 7200 RPM or faster
- Ethernet: Gig-E (1000BaseT)

### Windows

Ethernet connection: Windows XP, Windows Vista, Windows 7 or Windows 8

### MacOS

Ethernet connection: System 7.5 to MacOS 9.2 (Open Transport recommended) or MacOS X

### Linux/other Unix

Ethernet connection: Hardware drivers, TCP/IP, and DHCP must be enabled in the kernel

Model  
Number

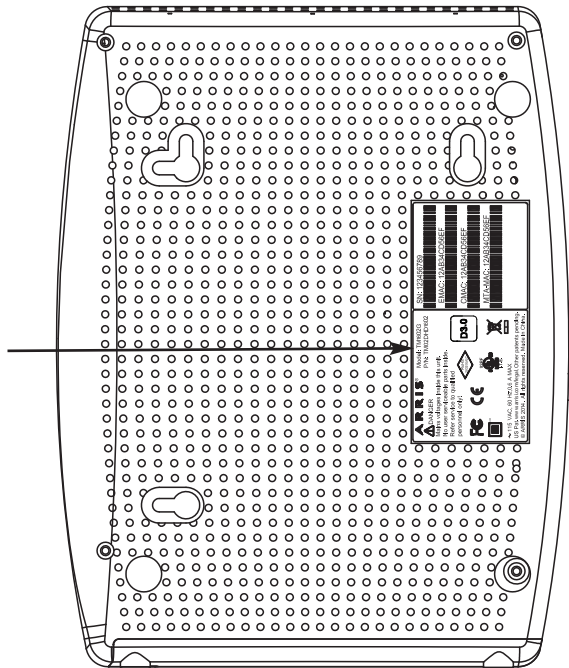

## About this Manual

This manual covers all of the different TM1602G models. Your model may not have all of the capabilities outlined in this manual. To determine which model you have purchased, refer to the image at the left. The model number is on the label affixed to the Telephony Modem.

## Ethernet Connection

Ethernet is a standard method of connecting two or more devices into a Local Area Network (LAN). Use the Ethernet connection if your computer has built-in Ethernet hardware or you want to share the Telephony Modem connection with several computers.

**Note:** To connect two or more computers to the Ethernet port, you will need a hub or broadband router (available at computer retailers).

The Telephony Modem package comes with a 4-foot (1.2m) Ethernet cable (the connectors look like wide telephone connectors); you can purchase more cables if necessary at a computer retailer. If you are connecting the Telephony Modem directly to a computer, or to an Ethernet hub or broadband router with a cross-over switch, ask for Category 5e (CAT5e) straight-through cable. CAT5e cable is required for gigabit Ethernet (Gig-E), not regular CAT5 cable.

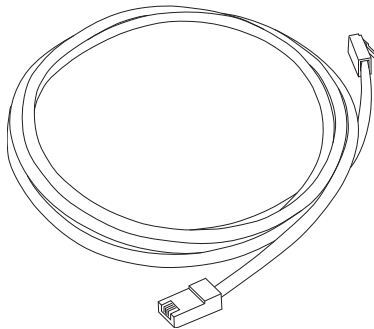

**Ethernet Cable**

## What About Security?

Having a high-speed, always-on connection to the Internet requires a certain amount of responsibility to other Internet users—including the need to maintain a reasonably secure system. While no system is 100% secure, you can use the following tips to enhance your system's security:

- Keep your operating system updated with the latest security patches. Run the system update utility at least weekly.
- Keep your email program updated with the latest security patches. In addition, avoid opening email containing attachments, or opening files sent through chat rooms, whenever possible.
- Install a virus checker and keep it updated.
- Avoid providing web or file-sharing services over your Telephony Modem. Besides certain vulnerability problems, most cable companies prohibit running servers on consumer-level accounts and may suspend your account for violating your terms of service.
- Use the cable company's mail servers for sending email.
- Avoid using proxy software unless you are certain that it is not open for abuse by other Internet users (some are shipped open by default). Criminals can take advantage of open proxies to hide their identity when breaking into other computers or sending spam. If you have an open proxy, your cable company may suspend your account to protect the rest of the network.



**Basic Backup Battery**



**Extended Backup Battery**

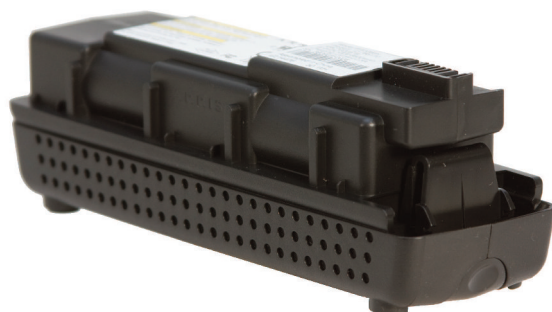

**Maximum Backup Battery**

## Battery Installation and Replacement

The TM1602G Telephony Modem may optionally include a Lithium-Ion battery to provide continued telephone service during power outages. The battery backup is not intended to take the place of AC power.

Your cable company may include a backup battery with your Telephony Modem. You can order batteries at <http://www.arrismodemsite.com/>

**Note:** For safety and regulatory purposes, batteries are shipped outside of the Telephony Modem and must be installed.

The TM1602G supports the following battery models:

- **Basic backup battery** — provides up to 6 hours (black) or 8 hours (green) of backup time, depending on your Telephony Modem model and usage. It may be green or black.

[Basic Battery Installation and Replacement](#)

- **Extended backup battery** — provides up to 12 hours of backup time, depending on model and usage. It has a strap between the battery guides. It may be light grey or black.

[Extended Battery Installation and Replacement](#)

- **Maximum backup battery** — provides up to 18 hours (6-cell) or 24 hours (8-cell) of backup time, depending on model and usage. It replaces the battery door, and increases the height of the Telephony Modem by about 5/8 inch (16 mm).

[Maximum Battery Installation and Replacement](#)

## Basic Battery Installation and Replacement

This model of the Telephony Modem has the ability to provide battery backup in the event of a local power loss. The battery backup is not intended to take the place of AC power.

Use this procedure to install and to replace the backup battery.

- 1 Press down and pull back on the latch holding the battery door (on the bottom of the Telephony Modem). Pull the door toward you. Set the door aside in a safe place.

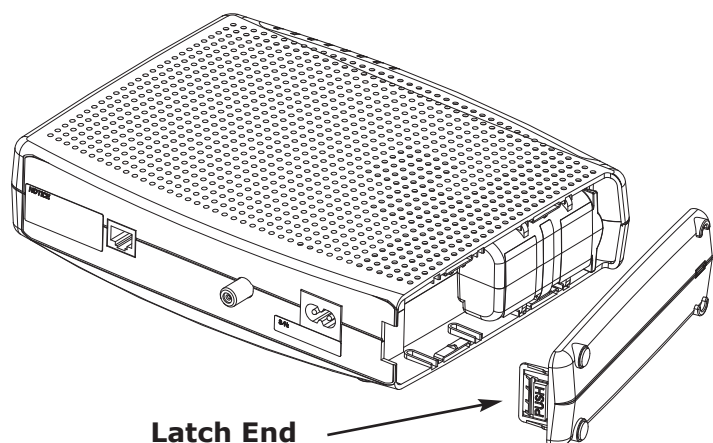

### CAUTION Risk of equipment damage

Improperly inserting the battery may damage the battery connector in the Telephony Modem. Carefully follow the instructions in the next step to avoid damage.

- 2 Hold the battery pack so that the guides on the battery align with the slots on the Telephony Modem and slide the battery into the bay. The diagram on the left shows the proper orientation.

**Note:** Batteries will not insert completely into the Telephony Modem if not oriented correctly. The battery should slide into the bay without significant force. Line up the guides on the battery with the slots in the battery bay.

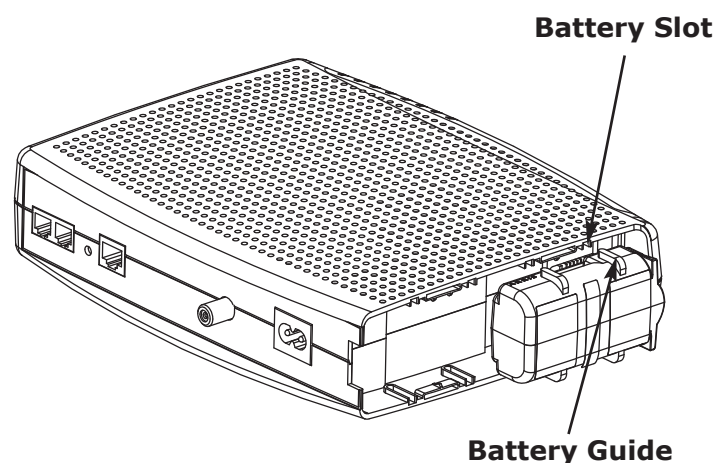

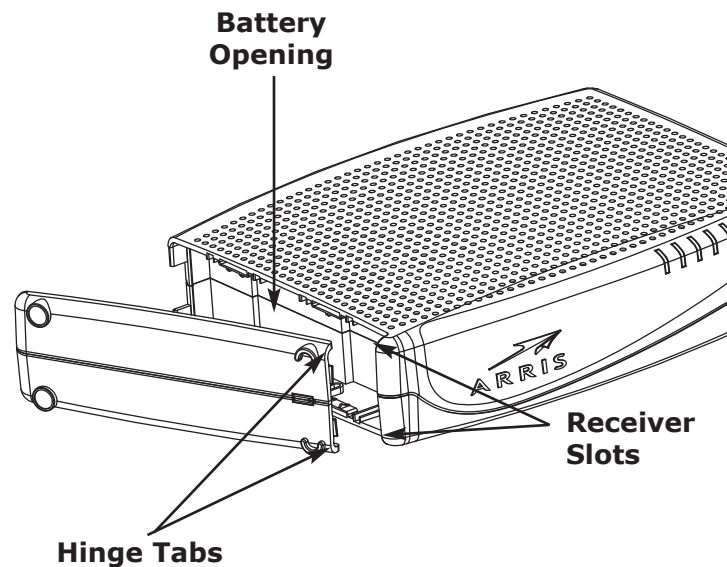

- 3 Push the battery pack into the bay until it seats into place. **If you are taking the battery out of the Telephony Modem, position your finger in the battery opening area and use leverage to dislodge the battery while pulling it straight back.**

**Note:** The Telephony Modem will not begin operating until you apply AC power.

- 4 Replace the door. To do so, place the hinge tabs of the battery door into the receiver slots inside the Telephony Modem battery compartment on the opposite end of the battery opening slot. Rotate the door toward the unit until the latch snaps back into place.

**Note:** Telephony Modems use a Lithium-Ion battery pack. Please recycle or dispose of the battery responsibly and in accordance with local ordinances.



## Extended Battery Installation and Replacement

Use this procedure to install or replace the backup battery.

- 1 Press down and pull back on the latch holding the battery door (on the bottom of the Telephony Modem). Pull the door toward you. Set the door aside in a safe place.

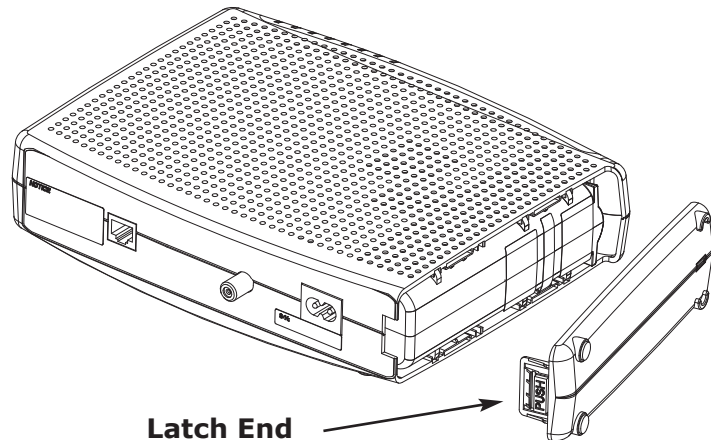

### CAUTION Risk of equipment damage

Improperly inserting the battery may damage the battery connector in the Telephony Modem. Carefully follow the instructions in the next step to avoid damage.

- 2 Hold the battery pack so that the guides on the battery align with the slots on the Telephony Modem and slide the battery into the bay. The diagram on the left shows the proper orientation.

**Note:** Batteries will not insert completely into the Telephony Modem if not oriented correctly. The battery should slide into the bay without significant force. Line up the slots in the battery bay with the guides on the battery and apply even pressure on both ends of the battery.

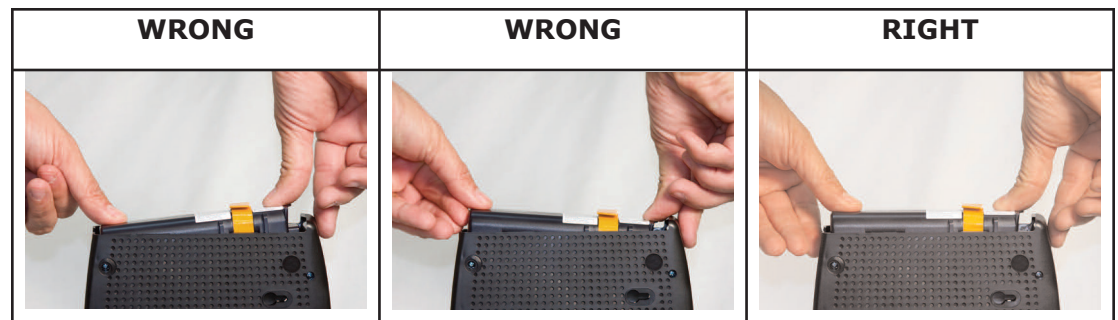
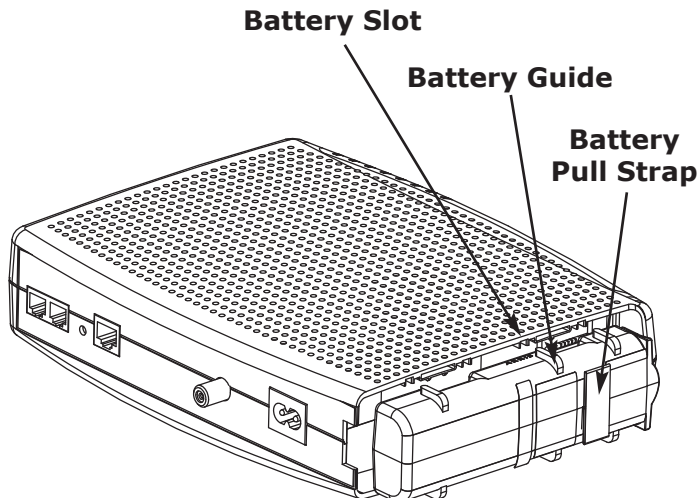

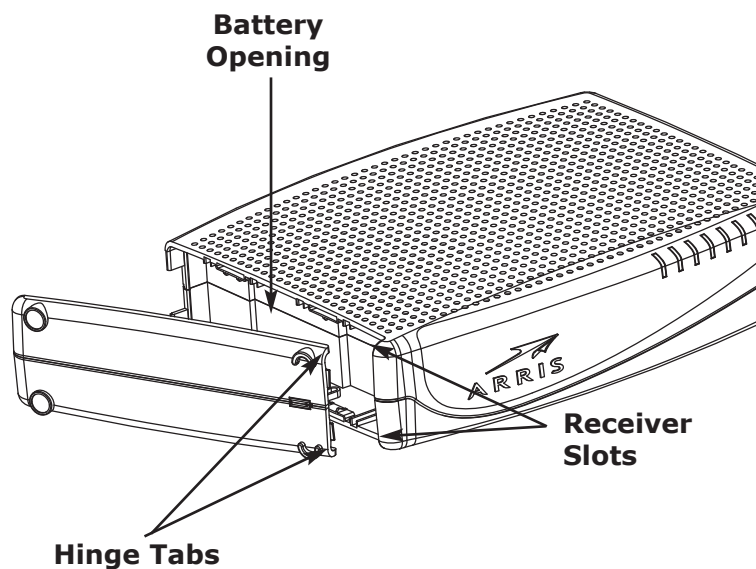

- 3 Push the battery pack into the bay until it latches into place. **If you are taking the battery out of the Telephony Modem, use the battery pull strap to dislodge the battery.**

**Note:** The Telephony Modem will not begin operating until you apply AC power.

- 4 Replace the door. To do so, place the tabs of the battery door into the slot on the Telephony Modem battery compartment. Rotate the door toward the front of the Telephony Modem until the latch snaps back into place.

**Note:** Telephony Modems use a Lithium-Ion battery pack. Please recycle or dispose of the battery responsibly and in accordance with local ordinances.

## Maximum Battery Installation and Replacement

Use this procedure to install or replace a maximum backup battery.

- 1 Press down and pull back on the latch holding the battery door (on the bottom of the Telephony Modem). Pull the door toward you. Set the door aside in a safe place.

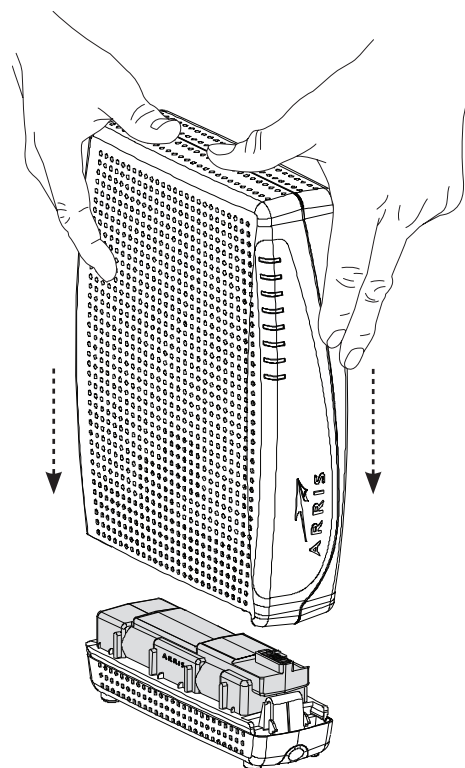
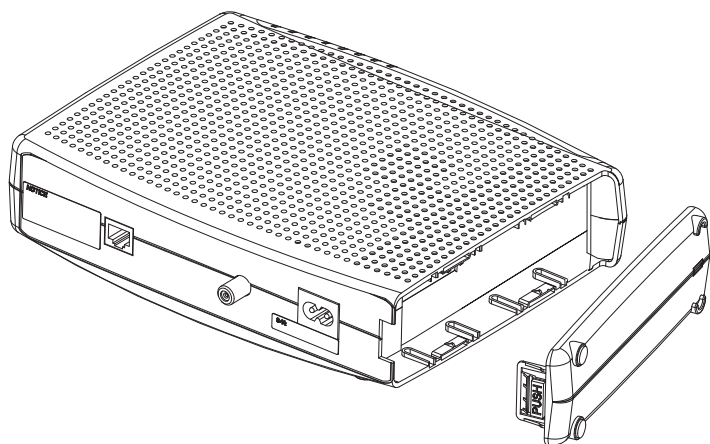

- 2 Place the battery on a firm horizontal surface.
- 3 Position the Telephony Modem over the battery, aligning the slots on the battery bay with the tabs on the battery. Push straight down on the Telephony Modem until the battery latch clicks into place.

**Note:** You may need to push down gently on the front of the Telephony Modem to latch the battery into place. The Telephony Modem will not begin operating until you apply AC power.

- 4 To remove the battery, grasp the battery and pull back on the latch at the front of the battery. Then gently rock the battery out of the bay.

**Note:** Telephony Modems use a Lithium-Ion battery pack. Please recycle or dispose of the battery responsibly and in accordance with local ordinances.

## Installing and Connecting Your Telephony Modem

Before you start, make sure that:

- You have contacted your cable company and verified that they provide data and telephone service using standard DOCSIS technology.
- You have all the [Items You Need](#).
- Cable, phone, and power outlets are available near the computer. If a cable outlet is not conveniently located, your cable company can install a new one.

If you have ordered service, your cable company should configure the Telephony Modem automatically. You need only follow the instructions in this section to install and connect the Telephony Modem.



### **CAUTION**

#### **Risk of equipment damage**

Only qualified installation technicians should connect the Telephony Modem to house wiring. Incumbent telephone service must be physically disconnected at the outside interface box before making any connections.

---

## Front Panel

The front of the Telephony Modem provides the following indicators.

- A Battery:** indicates battery status.
- B Tel 2:** indicates status of telephone line 2.
- C Tel 1:** indicates status of telephone line 1.
- D Online:** indicates Internet data transmission status.
- E US/DS:** indicates upstream/downstream connectivity.
- F Power:** indicates whether AC power is available to the unit.

## Rear Panel

The rear of the Telephony Modem has the following connectors and controls:

- A Tel 1 (grey):** connector for the first phone line.
- B Tel 2 (grey):** connector for the second phone line.
- C Reset button:** resets the Telephony Modem as if you power cycled the unit. Use a pointed **non-metallic** object to press this button.
- D Ethernet** connector (yellow): for use with a computer or home network LAN connection.
- E Cable:** connector for the [coax cable](#).
- F Power:** connector for the power cord.

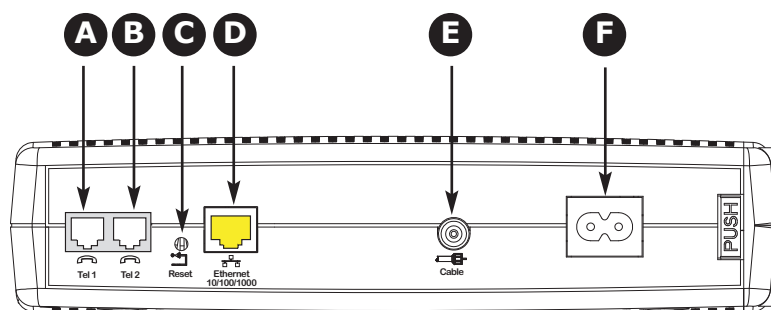
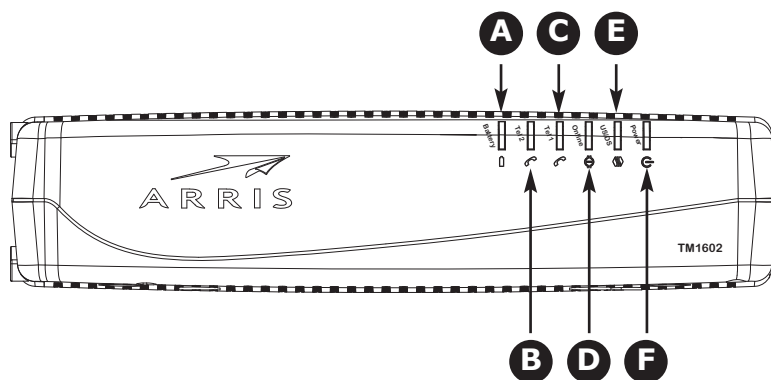

## Mounting the Telephony Modem

You can either mount the Telephony Modem on a wall or place it on a desktop. For wall-mount applications, you can mount the Telephony Modem with the indicators facing upward (vertical) or to the side (horizontal).

### Tools and Materials

For wall-mounted installations, make sure you have the following tools and materials before proceeding:

- for mounting on drywall: Two 1/4" (6mm) drywall anchors (not included), two #6 x 1.5" (38.1 mm) self-tapping panhead screws (not included), and a drill with 1/4" (6mm) bit (not included)
- for mounting on plywood or studs: two #6 x 1.5" (38.1 mm) self-tapping panhead wood screws (not included)
- screwdriver (flat-blade or Phillips, depending on what kind of screws you use)

### Location

There are a number of factors to consider when choosing a location to install your Telephony Modem:

- Is an AC outlet available nearby? For best results, the outlet should not be switched and should be close enough that extension cords are not required.
- Is a cable jack available? For best performance, keep the number of splitters between the jack and cable drop to a minimum. Each splitter attenuates (reduces) the signal available to the Telephony Modem.
- Can you easily run cables between the Telephony Modem's location and the phones?
- If you are connecting devices to the Ethernet port, can you easily run cables between the Telephony Modem's location and the device?



Step 1

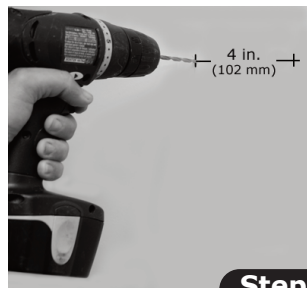

Step 2



Step 3



Step 4

## Instructions

### Wall-mounting instructions

**Note:** When mounting the Telephony Modem on drywall, try to position the Telephony Modem so at least one of the screws is fastened to a stud. This may prevent the Telephony Modem from pulling out of the wall in the future. To prevent overheating of the Telephony Modem, do not block the ventilation holes on the sides of the unit.

- 1 Position the Telephony Modem on the surface where you intend to mount it. Orient the Telephony Modem with the indicator lights facing up or right, as desired.
- 2 Drill two holes, 4 inches (102mm) apart, in the correct locations for the mounting screws.
- 3 If using drywall anchors, set them into the wall. Then, drive the screws into the wall leaving a gap of about 1/8" (3 mm) between the screw head and the wall. If not using anchors, just drive the screws.
- 4 Slip both mounting slots (in the back of the Telephony Modem) over the screws, then slide the case down until the narrow end of the keyhole slot contacts the screw shaft.
- 5 Proceed to [Connecting the Telephony Modem](#).

### Desktop mounting instructions

- 1 Position the Telephony Modem so that:
  - air flows freely around it
  - the back faces the nearest wall
  - it will not fall to the floor if bumped or moved
  - the ventilation holes on the side of the unit are not blocked
- 2 Proceed to [Connecting the Telephony Modem](#).

## Connecting the Telephony Modem



### WARNING Risk of injury or equipment damage

Connecting the Telephony Modem to the home's existing telephone wiring should only be performed by a professional installer. Physical connections to the previous telephone provider must be removed and the wiring must be checked; there must not be any voltage. Cancellation of telephone service is not adequate. Failure to do so may result in loss of service and/or permanent damage to the Telephony Modem.

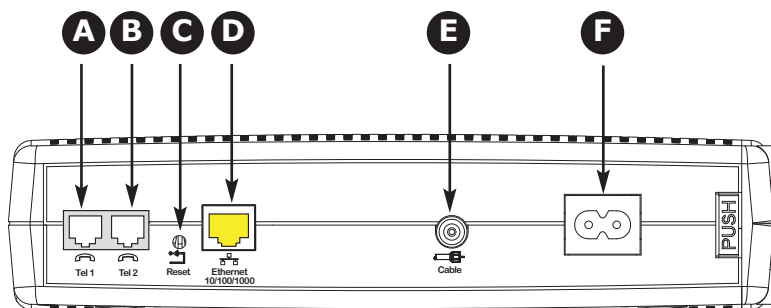

- 1 Connect one end of the coax cable to the cable outlet or splitter, and the other end to the Telephony Modem's Cable connector (E). Tighten the connections by hand, then tighten an additional 1/8 turn with a wrench.

**Note:** For best performance, use high-quality RG-6 type coax cable and minimize or eliminate splitters between the cable jack and the Telephony Modem.

- 2 Insert the plug from the power cord into the Power connector on the Telephony Modem (F) and insert the power cord into a convenient AC outlet.

*The Power light on the front of the Telephony Modem lights up, then flashes once (refer to the Indicator Lights table for your model). See [Troubleshooting](#) if the Power light does not turn on.*

### Making Ethernet Connections

- 3 Connect one end of the yellow Ethernet cable to the yellow port on the back of the Telephony Modem labeled "Ethernet 10/100/1000," (D) and the other end to the Ethernet port on a computer, hub, or broadband router.

**Note:** If you are connecting to a computer, use the Ethernet cable included in the Telephony Modem package.

### Making Telephone Connections

- 4 Connect one end of the telephone cable to one of the grey telephone ports on the back of the Telephony Modem (A or B). Connect the other end to the telephone.



## Configuring Your Ethernet Connection

If your computer is equipped with a LAN card providing an Ethernet connection, you may have to configure your computer's TCP/IP settings. The steps that follow will guide you through setting your computer's TCP/IP settings to work with the Telephony Modem.

### Requirements

Make sure you have the following before attempting to configure your Ethernet connection:

- Computer with:
  - one of: Windows XP, Windows Vista, Windows 7, Windows 8, or MacOS X
  - Ethernet interface
- Ethernet cable (supplied)
- IP address, subnet, gateway, and DNS information for installations not using DHCP

### How to use this chapter

The following list shows the procedures for modifying the TCP/IP settings on the computer. The procedure is slightly different depending on the operating system that you are using. Please ensure you are using the correct steps for the operating system on your computer. Follow the links below for instructions to configure your Ethernet connection on your operating system.

- [TCP/IP Configuration for Windows XP](#)
- [TCP/IP Configuration for Windows 7](#)
- [TCP/IP Configuration for MacOS X](#)

**Note:** For **Windows 8** and **Windows Vista**, use the Windows 7 procedure. They are very similar.

## TCP/IP Configuration for Windows XP

Follow these steps to configure the Ethernet interface on a Windows XP operating system.

**TCP/IPv6 Note:** This procedure shows the configuration of TCP/IPv4. TCP/IPv6 is not installed or enabled by default in Windows XP. If your cable company requires TCP/IPv6 you must first install and enable it on your Windows XP system. Refer to Microsoft support materials on Windows XP for installation instructions. Once installed and enabled, follow this same configuration example, but select TCP/IPv6 at the appropriate step.

**Note:** Dialog boxes shown on your computer may differ slightly from those shown in this procedure.

- 1 From the computer, select **Start > Settings > Control Panel** and double-click **Network Connections** in the Control Panel.

*The Network Connection window displays a list of LAN connections and associated network adapters.*

- 2 Double-click the local area connection to be used for your device's network connection.

*The Local Area Connection Status window displays.*

- 3 Click **Properties**.
- 4 Select **TCP/IP** by clicking it one time. Then click **Properties**.
- 5 Click the **General** tab. Then click **Obtain an IP address automatically** and click **OK**.
- 6 Click **OK** to accept the new settings, and **OK** again to close the Properties window.
- 7 You may have to restart your computer in order for your computer to obtain a new IP address from the network.

## TCP/IP Configuration for Windows 7

Follow these steps to configure the Ethernet interface on a Windows 7 operating system.

- 1 Open the Windows 7 Control Panel.
- 2 Click **Network and Internet**.
- 3 Click **Network and Sharing Center**.
- 4 Click **Local Area Connection** to open the Status window.
- 5 Click **Properties** to open the Properties window.
- 6 Select **Internet Protocol Version 4 (TCP/IPv4)** and click **Properties** to configure TCP/IPv4.

**Note:** If your cable company requires TCP/IP version 6, select **Internet Protocol Version 6 (TCP/IPv6)** and click **Properties** to configure TCP/IPv6.

*The TCP/IP properties window for the version you selected displays.*

- 7 For either TCP/IPv4 or TCP/IPv6, select **Obtain an IP address automatically** and **Obtain DNS server address automatically**, unless instructed otherwise by your cable company.
- 8 Click **OK** to accept the new settings and close the Properties window. Then click **Close** to back out of the remaining setup screens.

## TCP/IP Configuration for MacOS X

Follow these steps to configure the Ethernet interface on a MacOS X operating system.

- 1 Open System Preferences, either by choosing System Preferences from the Apple menu or by clicking the System Preferences icon in the dock.
- 2 Click the **Network** icon.
- 3 Choose **Automatic** from the Location drop-down menu, and **Built-in Ethernet** from the Show menu.
- 4 Choose the TCP/IP tab, if necessary.  
If you are using **TCP/IPv4**, go to **step 5**.  
If your cable company requires **TCP/IPv6**, go to **step 8**.
- 5 Choose **Using DHCP** from the Configure IPv4 menu.
- 6 If necessary, click the **Renew DHCP Lease** button.
- 7 Close the System Properties application.  
*TCP/IPv4 configuration is completed.*
- 8 If you are using TCP/IPv6, click **Configure IPv6** near the bottom of the previous window.
- 9 Choose **Automatically** from the Configure IPv6 drop-down menu and click **OK**.
- 10 Close the System Properties application.

## Using the Telephony Modem

This chapter describes the controls and features available on the Touchstone Telephony Modem, and covers basic troubleshooting procedures.

- [Setting up Your Computer to Use the Telephony Modem](#)
- [Indicator Lights for the TM1602G](#)
- [Using the Reset Button](#)
- [Booting from Battery](#)

### Setting up Your Computer to Use the Telephony Modem

Follow the instructions in the information packet supplied by your cable company. Contact your cable company if you need help setting up your computer.

#### Wiring Problems

If the Telephony Modem begins flashing all its lights for more than 10 seconds, this indicates a problem with the telephone wiring—the red and green wires may be shorted (touching), or there may be undesired voltage on the lines. If this pattern persists for more than 10 seconds, disconnect the telephone lines from the Telephony Modem, then call a wiring technician for assistance.

## Indicator Lights for the TM1602G

The Touchstone Telephony Modem has indicator lights to assist in troubleshooting.

### Battery Mismatch

If the Telephony Modem alternates flashing the Battery light and all other lights, the installed battery is incompatible with the Telephony Modem. Remove the battery and install one of the batteries described in [Battery Installation and Replacement](#).

### Indicator Lights: Normal Operation

The following table shows light patterns during normal operation. If colors are not indicated, they do not affect the status.

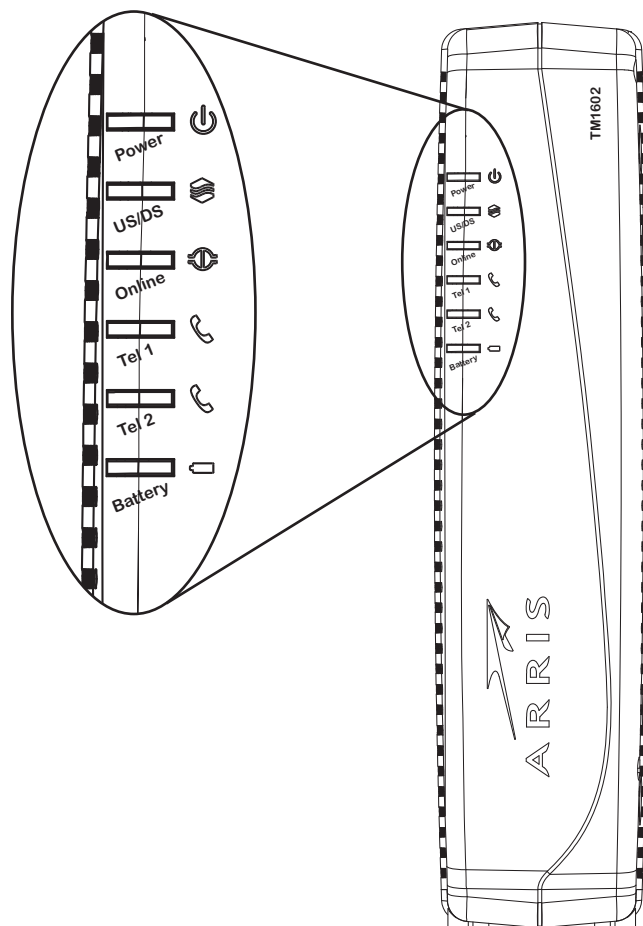

Mode	Power	Ethernet (rear panel)	US/DS	Online	Tel 1/Tel 2	Battery
AC Power Good	On	<p><b>Green LED On</b> = Computer with 1 Gbps port connected</p> <p><b>Amber LED On</b> = Computer with 100 Mbps/10 Mbps port connected</p> <p><b>Amber/Green LED Flash</b> = Computer activity</p> <p>Both LEDs Off = Computer not connected</p>	<p><b>On</b> = Connected to the Internet</p> <p>Flash = Not connected to the Internet</p>	<p><b>On</b> = Internet Available</p> <p>Off = Internet not available</p>	<p><b>On</b> = On-hook</p> <p>Flash = Off-hook</p> <p>Off = disabled</p>	<p><b>On</b> = Battery good or low</p> <p>Off = Battery missing or MTA not registered</p> <p>Flash = Battery bad</p>
No AC Power Battery Installed	Flash	Off	Off	Off	<p><b>On</b> = On-hook</p> <p>Flash = Off-hook</p> <p>Off = disabled</p>	<p>Off = Battery power</p> <p>Flash = Battery bad or low</p>
No AC Power No Battery	Off	Off	Off	Off	Off	Off
Firmware Upgrade	On	(normal operation)	Flash	On	(normal operation)	(normal operation)

**Indicator Lights: Startup Sequence**

The following table shows the Telephony Modem light patterns during each phase of the startup sequence. There are two phases of startup; the Telephony phase and the cable modem phase. Both are outlined below.

**Telephony Modem Start Up Sequence**

Power, US/DS, Online	Telephone		Description
	1	2	
Off	Off	Off	No power to Cable Modem
Flash	Flash	Flash	Power-on Self Test
"Cable Modem Start Up Sequence" Begins			
<b>On</b>	Flash	Off	Retrieving telephone network information
<b>On</b>	Off	Flash	Retrieving telephone line information
<b>On</b>	Flash	Flash	Activating telephone service
Normal Operation Begins			



### Cable Modem Start Up Sequence

The following table shows the start-up sequence for the cable modem portion of the Telephony Modem. Indicator color is not important.

US/DS	Online	Description
<b>Slow</b> Flash (1/second)	Off	Downstream acquisition in progress
<b>On</b> (until Upstream acquisition starts)	Off	Downstream acquisition completed
<b>Fast</b> Flash (3/second)	Off	Upstream acquisition completed
<b>On</b>	<b>Slow</b> Flash (during acquisition) <b>On</b> (when modem IP address obtained)	Upstream acquisition completed, ready for service

## Using the Reset Button

Use the **Reset** button, on the back of the Telephony Modem, to reset the modem as if you power cycled the unit. You may need to reset the Telephony Modem if you are having problems connecting to the Internet. Using this button will be rare.

Use a pointed **non-metallic** object to press this button. The photo to the left shows the location of the **Reset** button. The **Reset** button is recessed to prevent accidental resets.

## Booting from Battery

The TM1602G supports a "Boot from Battery" feature that allows the Telephony Modem to provide continued telephone service during power outages.

To start the TM1602G from its battery, follow these steps:

- 1 If a battery is already installed in the Telephony Modem, remove it.
- 2 Re-insert the battery into the Telephony Modem (see [Battery Installation and Replacement](#) for details).
- 3 Press the **Reset** button; the Power light should turn on immediately.

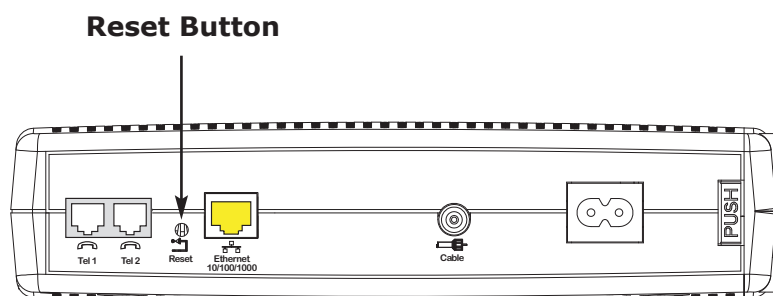

## Troubleshooting

### The Telephony modem is plugged in, but the Power light is off.

Check all power connections. Is the power cord plugged in firmly at both ends?

If you plugged the power cord into a power strip, make sure the strip is switched on.

Avoid using an outlet controlled by a wall switch, if possible.

Check the outlet by plugging in another device (such as a lamp).

Finally, check the fuse or circuit breaker panel.

### I'm not getting on the Internet.

It may take over 30 minutes to establish a connection the first time you power up your Telephony Modem, especially when many people are online. Always leave your Telephony Modem plugged into AC power and connected to the cable system.

Check the front panel lights:

- The **Power** and **Online** lights should be on.
- If the **Power** light blinks for more than 30 minutes, call your cable company for assistance.

Check your cable connections. Connectors should be tight. The [coax cable](#) should not be pinched, kinked, or bent sharply—any of these can cause a break or short in the cable (you may have to replace the cable). If you have one or more splitters between the Telephony Modem and CATV outlet, remove the splitters and connect the Telephony Modem directly to the outlet.

Proceed to the Ethernet solution (next page) if necessary.

**I'm not getting on the Internet. (Ethernet)**

If you are using a hub, is the hub turned on?

Are you using the right type of [Ethernet](#) cable? Use the supplied cable for direct connection to a computer; use a cross-over cable for connection to a hub or home router.

Press the Reset button on the back of the Telephony Modem.

**I can get on the Internet, but everything is slow.**

If the Web site you are visiting is very popular, that site may be having trouble servicing all the requests. If other sites download quickly, wait for a few minutes and try again. Usage during peak hours may also affect the connection speed.

If your Telephony Modem is connected to a LAN (Local Area Network), either directly or through a firewall, other communications on the LAN may slow down your connection.

To test your network speed, try an online test such as [http://reviews.cnet.com/Bandwidth\\_meter/7004-7254\\_7-0.html](http://reviews.cnet.com/Bandwidth_meter/7004-7254_7-0.html)

**I have two computers connected to the Telephony Modem, but only one can get on the Internet.**

Check your cable company's terms of service: they may allow only one computer to connect directly to the Telephony Modem.

**I don't have dial tone when I pick up my phone, why?**

In order for telephone service to be functional on the Telephony Modem, telephone service must have been purchased from the cable company and configured on your Telephony Modem. The following steps should help in identifying the source of the problem.

- Is the **Power** LED lit?

If not, check to make sure the Telephony Modem is plugged in and the outlet has power.

If the LED is lit, go to the next step.

- Is the **Online** LED lit?

If not, check the coax connection at the Telephony Modem and the wall. Ensure they are connected and tight. If they are and you do not have dial tone, contact your cable company.

If the **Online** LED is lit, go to the next step.

- Is the **Telephone** (Tel 1 or Tel 2) LED lit?

If not, phone service has not been provisioned on that line. Contact your cable company.

If it is blinking, there is a phone off hook somewhere in the house. Find that phone and hang it up.

If it is lit, go to the next step

- Is the phone plugged directly into the Telephony Modem?

Make sure the phone is plugged into the port on the back of the Telephony Modem labeled "Tel 1" for line 1, and "Tel 2" for line 2.

If so, try a different phone. Make sure the new phone is a working phone.

If a known good phone is used and you still don't have dial tone, try a different phone cable. If a new phone and cable do not restore dial tone, call your cable company.

- Is the Telephony Modem plugged into a wall outlet?

If so, unplug the RJ-11 connector at the back of the Telephony Port and plug in a known working phone. If you now have dial tone, the problem is with the house wiring. Contact your cable company or a qualified wiring technician to correct the house wiring. If you still do not have dial tone, contact your cable company.

## Glossary

The following is a list of common cable and networking terms.

### **Amp-hour (Ah)**

A measure of battery capacity. For example, a 1.0Ah battery can nominally supply one Ampere of current for one hour.

### **Category 5e (Cat5e)**

A high-quality type of cable, used for gigabit Ethernet (1000BaseT) connections. When purchasing Ethernet cables, always look for Category 5e cable.

### **Coaxial cable (coax)**

A thin wire, used to connect your television and Telephony Modem to the cable TV system. You can buy coax from any electronics retailer and many discount stores.

### **CPE**

Customer Premise Equipment. This is the equipment that is plugged in to the telephony modem; typically a computer, hub, or router.

### **Cross-over**

An Ethernet cable used to connect two hubs (or a hub and a cable modem) together. Also, some Ethernet hubs may have built-in cross-over on one or more ports (which eliminates the need for a cross-over cable).

### **DHCP**

Dynamic Host Configuration Protocol. An IP protocol used to provide an IP address and location of services (such as DNS and TFTP) needed by a device connecting to the network. DHCP allows the cable company to configure your computer's networking software for you.

### **DNS**

Domain Name Service (Server). An IP service that associates a domain name (such as www.example.com) with an IP address.

**Downstream**

In an HFC network, the direction from the head-end to the subscriber. Some older cable documentation may refer to this as the forward path.

**DOCSIS**

Data Over Cable System Interface Specification. The interoperability standards used for data communications equipment on an HFC network.

**EMTA**

Embedded Multimedia Terminal Adapter. An MTA device that is integrated with a cable modem.

**Ethernet**

A standard method of connecting two or more computers into a Local Area Network (LAN).

**Euro-DOCSIS**

The European version of DOCSIS.

**Event**

An informational message used for monitoring network status.

**F-connector**

The type of connector used on coax cable. There are two common types of F-connector, slip-on and screw-on. Use coax with screw-on connectors for connecting your Telephony Modem.

**Headend**

The "central office" in an HFC network. The headend houses both video and data equipment. In larger cable networks, a "master" headend often feeds several "remote" headends to provide distributed services.

**HTTP**

HyperText Transfer Protocol.

**Hub**

A box with several Ethernet connectors. Ethernet hubs provide a common point of contact for all connected devices.

**IP address**

A number assigned to your computer by your cable company, used to identify your computer to other systems on the Internet.

**ISDN**

Integrated Services Digital Network. A digital telephony standard that provides communication speeds about twice as fast as standard dialup.

**LAN**

Local Area Network. A network that allows computers in a single location (such as a building) to communicate with one another.

**LED**

Light Emitting Diode. A semi-conductor diode that emits light when current is passed through it.

**MAC address**

A number that uniquely identifies any device connected to a network. Your cable company uses your Telephony Modem's MAC address to authorize access to the Internet. The MAC address is printed on a label on the bottom of your Telephony Modem.

**Protocol**

A set of rules and formats that determines the communication behavior of network entities at a given layer.

**Proxy**

A device or program that stands in between a server (for example, a web site) and a client (your browser), providing a way to relieve some of the burden from the server. For example, your cable company may have a web proxy that keeps copies of popular web pages; the proxy can send you those pages instead of fetching them directly from the web site, resulting in faster page loading and less network congestion.

**RF**

Abbreviation for Radio Frequency. Some literature refers to coax as "RF cable" and the connectors as "RF connectors."



**RJ-11**

A standard 2-conductor modular connector, commonly used in North America for connecting telephones.

**RJ-45**

A standard 8-conductor modular connector, commonly used on Ethernet cable. An RJ-45 connector looks like a wide RJ-11 (telephone) connector.

**Splitter**

A small box with three cable connectors: one input and two outputs. You may need a splitter if you have a TV already connected to the cable outlet that you want to use for your Telephony Modem. You can buy a splitter from any electronics retailer and most discount stores.

**Switched outlet**

A power outlet that may be turned on and off using a wall switch. Usually intended for lamps. Avoid plugging your computer or Telephony Modem into a switched outlet to avoid disruptions.

**TCP/IP**

Transmission Control Protocol/Internet Protocol. The protocols used to facilitate communications across one or more connected networks.

**TDMA**

Time Division Multiple Access. A method used by DOCSIS-compliant cable modems for sending upstream data with minimal interference.

**Upstream**

The path from a subscriber device to the headend. Some older cable documentation may refer to this as the return path or reverse path.

# **Touchstone® TM1602G Telephony Modem User's Guide**



©ARRIS Enterprises, Inc. 2015 All rights reserved. No part of this publication may be reproduced in any form or by any means or used to make any derivative work (such as translation, transformation, or adaptation) without written permission from ARRIS Enterprises, Inc. ("ARRIS"). ARRIS reserves the right to revise this publication and to make changes in content from time to time without obligation on the part of ARRIS to provide notification of such revision or change.

ARRIS provides this guide without warranty of any kind, implied or expressed, including, but not limited to, the implied warranties of merchantability and fitness for a particular purpose. ARRIS may make improvements or changes in the product(s) described in this manual at any time. The capabilities, system requirements and/or compatibility with third-party products described herein are subject to change without notice.

ARRIS and the ARRIS logo are all trademarks of ARRIS Enterprises, Inc. Other trademarks and trade names may be used in this document to refer to either the entities claiming the marks and the names of their products. ARRIS disclaims proprietary interest in the marks and names of others.

Protected under the following U.S. patent: 7,031,435.  
Other patents pending.

Release 16 Standard 1.3  
January 2015