

Terayon Communication Systems



TJ 700x Series DOCSIS™ Modem
Installation Guide



Part No. 8500229 Rev. C

4988 Great America Parkway
Santa Clara, CA 95054
www.terayon.com

Contents

Installation Guide

Congratulations	1
Getting Started	1
Package Contents	1
Terayon TJ 700x Series Cable Modem Package Contents	1
System Requirements	3
Installation Overview	3
What You Will Need	3
Connecting the Modem	4
Modem Connectors	5
Connecting the CATV Coaxial Cable to the Modem	6
Connecting the Modem to your PC	7
Making Ethernet Connections	8
Making USB Connections	10
Connecting Two PCs to the TJ 700x Series Modem	12
Technical Stuff	12
Connecting the Power Adapter and Startup	14
Connecting the Power Adapter to the Modem	14
Starting the Modem	14
Reading Your Modem Lights	16
Wall Mounting	17
Frequently Asked Questions (FAQs)	18
Troubleshooting	20
Problem:	20
Possible solution:	20
Problem:	20
Possible Solution:	20
Problem:	21
Possible Solution:	21
Problem:	21
Possible Solution:	21
Installation Guide Removal	22
Technical Support	23
Visit Our Web Site	23

Installation Guide

Congratulations

Congratulations on your purchase of a Terayon DOCSIS Cable Modem. The Terayon TJ 700x Series DOCSIS Cable Modem is the perfect choice for connecting your personal computer to a fast broadband Internet connection.

Getting Started

This installation guide is designed for anyone who wants all the “how-to” information about installing the Terayon TJ 700x Series Data-Over-Cable Interface Specification (DOCSIS) Cable Modem. You have probably heard of online help. Well, think of this installation guide as *onside* help. For best results, read each procedure beforehand—reviewing each procedure may answer some questions that could come up during the installation process. So let’s get started.

Package Contents

Please take a moment to unpack your modem and familiarize yourself with all the cables and components included in the box. Use the list below and Figure 1 to verify the contents of the box.

Terayon TJ 700x Series Cable Modem Package Contents

- Terayon Model TJ 700x Series DOCSIS Cable Modem
- Cable Modem Power Adaptor
- RJ-45 Ethernet Cable
- Universal Serial Bus (USB) Cable
- CD-ROM with USB Drivers

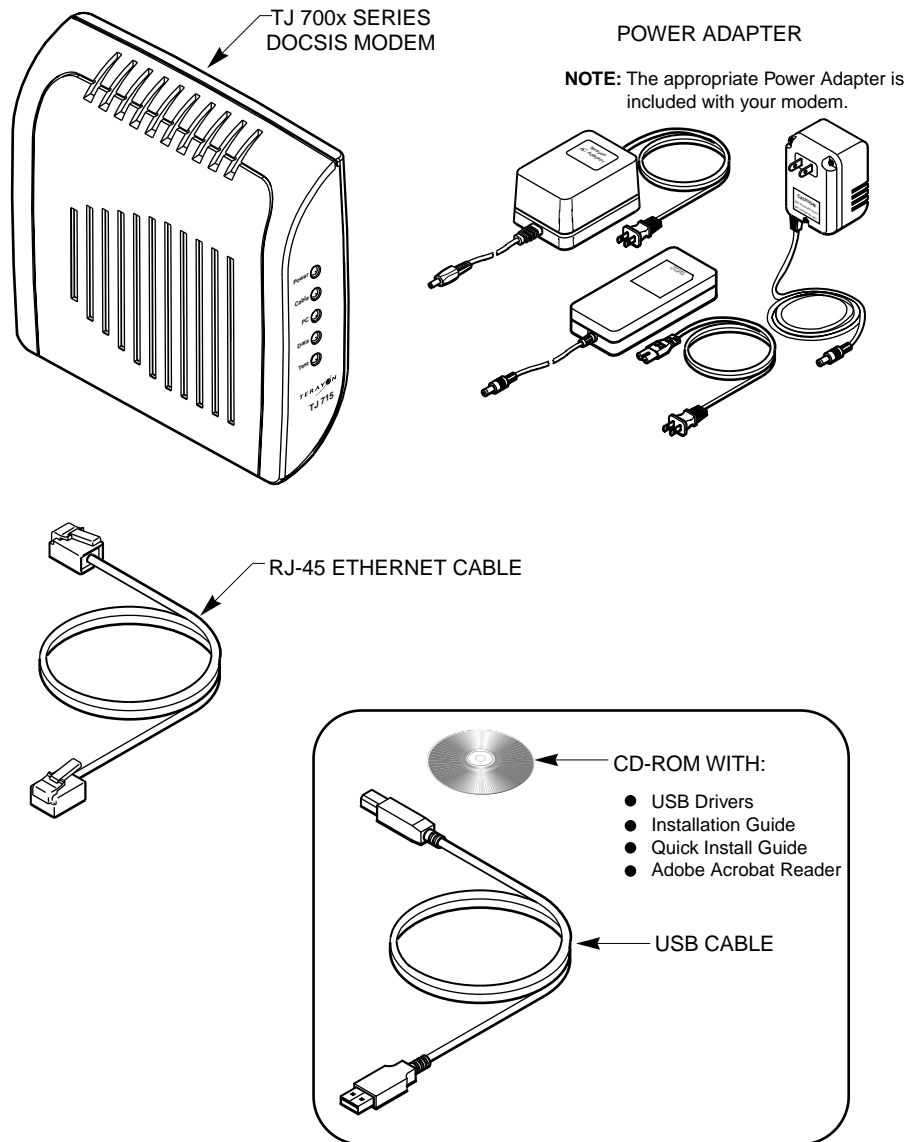

Figure 1 Contents of Cable Modem Box

System Requirements

Before you begin installing your new Terayon cable modem, make sure your computer system has the following hardware and software.

Hardware/Software	IBM PC or Compatible	Apple/Macintosh
CPU	Pentium class microprocessor or equivalent	Power PC 601 or later; iMac®
Memory (RAM)	32 MB	24 MB
Available Disk Space	50 MB	50 MB
Operating System	Windows® 95, 98, ME, 2000, XP, Windows NT® 4.0 Workstation	OS 7.5.1 or later
Network Connectivity	Must have (any one): <ul style="list-style-type: none"> • USB Port • 10/100 Base-T Ethernet Card • PCMCIA Ethernet Card (laptop) 	Must have (any one): <ul style="list-style-type: none"> • 10/100 Base-T Ethernet Card • PCMCIA Ethernet Card (laptop)



IMPORTANT: *Computers using Windows 95, NT 4.0, or a Macintosh operating system must use an Ethernet port to connect to the TJ 700x Series Modem*

Installation Overview

As you follow the self-installation process, you may be asked to perform some tasks you have not previously attempted. You will be guided through the following steps:

- Connecting the CATV Coaxial Cable to the Modem
- Connecting the Modem to your PC
- Connecting the Power Adapter and Startup.

What You Will Need

The following is a list of items you will need to install your new Terayon cable modem:

- This installation guide
- Your computer user manual
- The cable modem.

Connecting the Modem

To install your new cable modem, you will need the following items:

- Two coaxial cables of a length appropriate to your installation
- One cable line splitter
- A 7/16 inch (11.1 mm) wrench (spanner).

When installing your new cable modem a cable splitter and two new cables are required. The cable splitter divides the incoming signal from the cable company into two signals, one for the household TVs, and one for the cable modem. No TV sets are allowed on the cable that connects to the cable modem. Figure 2 illustrates a typical cable modem installation.

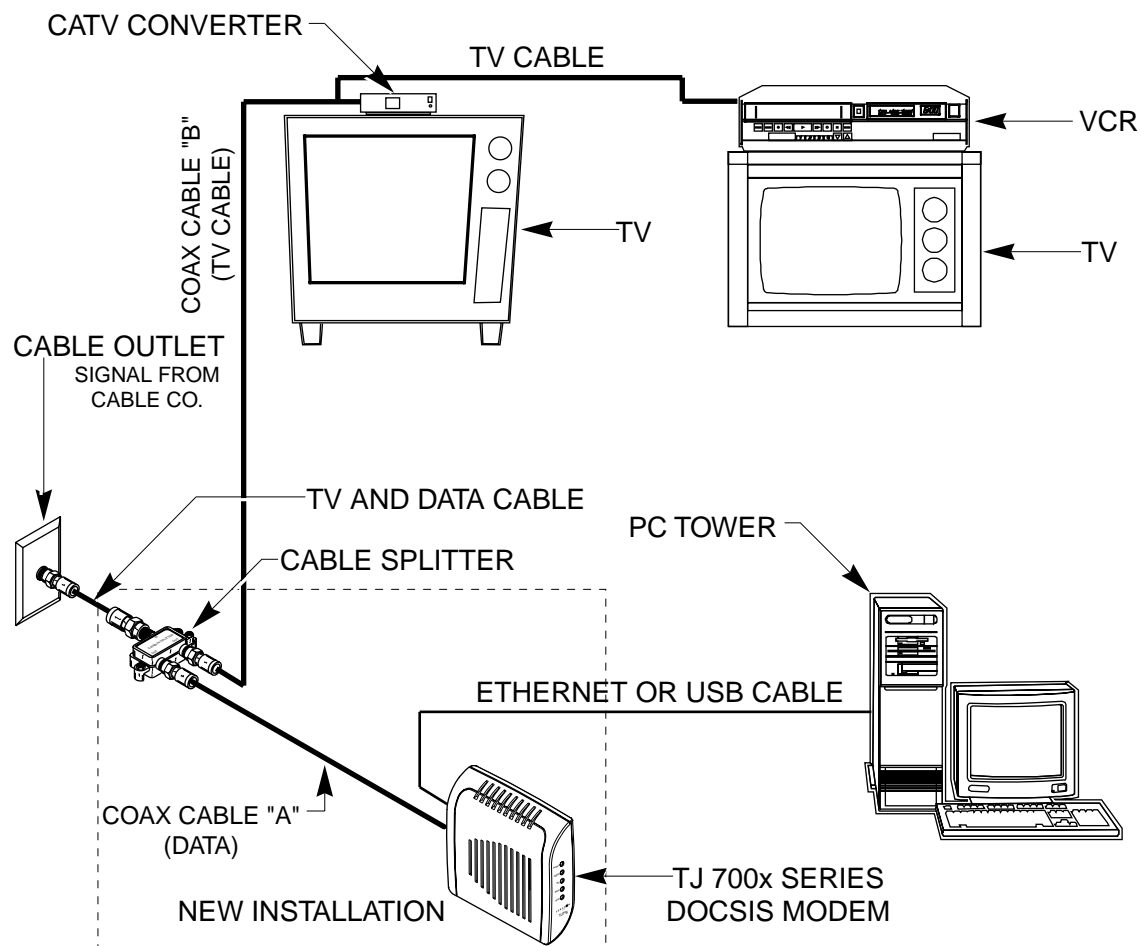

Figure 2 Typical Cable Modem Installation

Modem Connectors

Before you begin installing your new cable modem, take a moment to familiarize yourself with the modem connectors identified in Figure 3. An explanation of each connector follows the illustration.

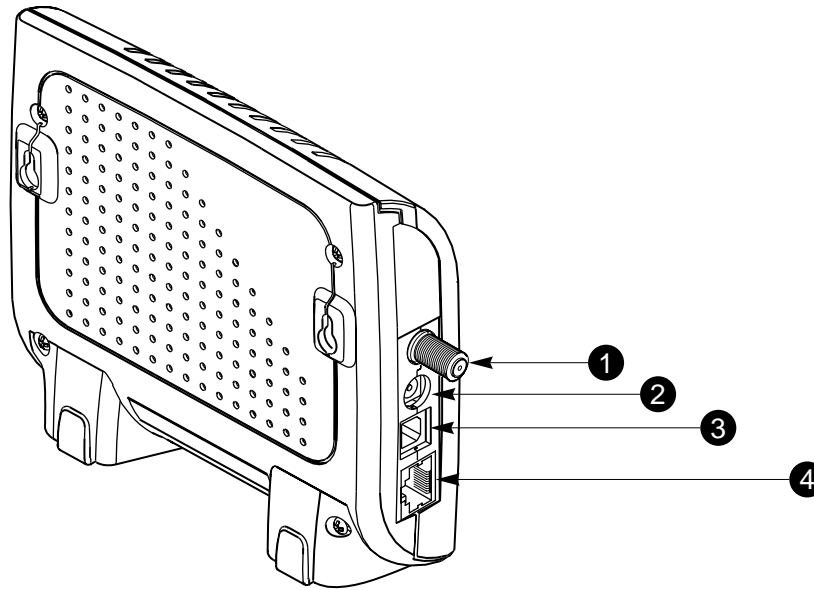

Figure 3 Modem Connectors

- | | |
|--------------------------------|--|
| 1 - RF Cable Connector | Connects the modem to the incoming signal from the cable company via a cable splitter. |
| 2 - DC Power Input-jack | Connects the modem to the Modem Power Adaptor. |
| 3 - USB Serial Port | Connects the modem to the USB port on your computer. |
| 4 - RJ-45 Ethernet Port | Connects the modem to the Ethernet port on your computer NIC card. |

Connecting the CATV Coaxial Cable to the Modem

In order for your cable modem and your computer to access the Internet, you need to connect the coaxial cable that comes from your cable outlet to the modem. This is typically done using a cable splitter. See Figure 2 on page 4.

To connect your modem to the CATV coaxial cable, follow these steps:

1. Locate the CATV coaxial cable connected to the cable outlet.

You can find it in one of three ways:

- It may be connected to a TV, Converter Box, or a VCR.
- It may be connected to a wall mounted outlet.
- It may be coming out from under a baseboard or some other location.

2. When you locate the CATV coaxial cable, disconnect it from the TV, Converter Box, or VCR.

You may need to use a wrench (spanner) to disconnect the cable.

3. Locate the cable splitter, then using Figure 2 and Figure 4 as guides, connect the CATV coax cable you disconnected in step 2 to the IN connector on the cable splitter. Tighten the connector with a 7/16 inch wrench.

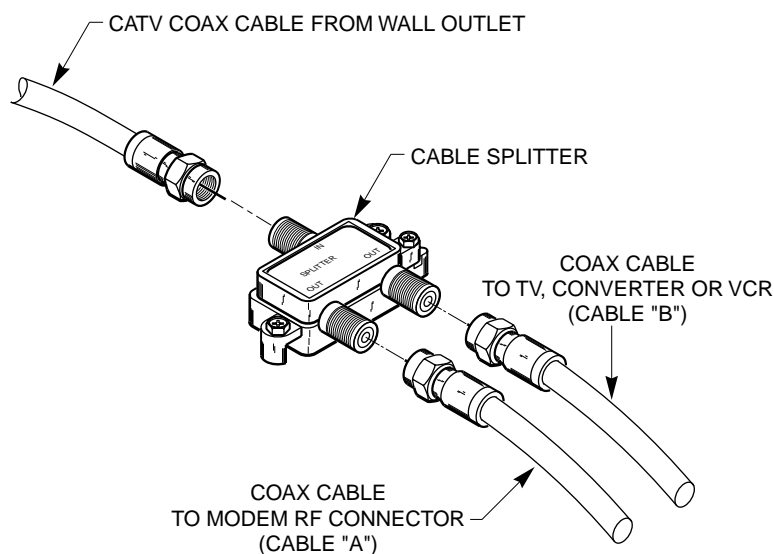

Figure 4 Connecting Coax Cable to Cable Splitter

4. Using Figure 2 and Figure 4 as guides, connect one end of a coax cable (Cable "B") to one of the OUT connectors on the cable splitter. Tighten the connector with 7/16 inch wrench.
5. Connect the remaining end of Cable "B" (TV Cable) to the same TV, Converter Box, or VCR.

6. Again, using Figure 2 and Figure 4 as guides, connect one end of coax Cable "A" (Data) to the remaining OUT connector on the cable splitter. Tighten the connection with a 7/16 inch (11.1 mm) wrench (spanner).
7. Remove your new cable modem from its box and place it near your computer.
8. Connect the remaining end of coax Cable "A" (Data) to the RF connector on the modem as shown in Figure 5. Tighten the connection with a 7/16 wrench (spanner).

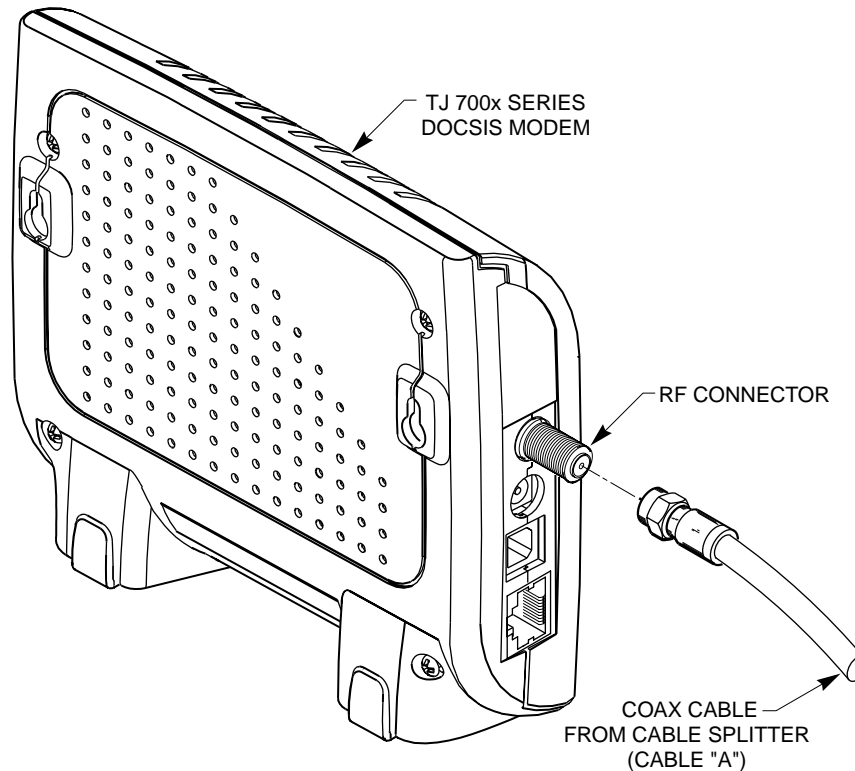

Figure 5 Connecting the RF Cable to the Modem

Connecting the Modem to your PC

In order for your computer to communicate with your new modem and the Internet, it must be equipped with a network interface. Today's computers are typically equipped with either a 10/100 Base-T Ethernet port or a Universal Serial Bus (USB) port. Terayon TJ 700x Series modems come equipped with RJ-45 Ethernet and USB connectors, allowing the modem to connect to either an Ethernet port or a USB serial port.



IMPORTANT: *If you are going to use just one PC with the modem, **do not** connect the modem to both the PC Ethernet and the USB port. Use either the USB or the Ethernet port, not both. Note that the Ethernet connection is preferable to the USB connection if both are available. The Ethernet connection is the fastest speed connection and will not be shared with other devices.*

Making Ethernet Connections



IMPORTANT: *If you do not have a network interface card installed in your computer, you will need to purchase one from a retailer or your local cable company, and install it according to manufacturer instructions.*

To connect the 10/100 Base-T Ethernet cable to the Terayon TJ 700x Series modem and your PC, follow these steps:

1. Retrieve the 10/100 Base-T Ethernet cable from the box the modem came in.
Use Figure 1 on page 2 to identify the cable.
2. Using Figure 6 on page 9 as a guide, connect one end of the 10/100 Base-T Ethernet cable to the RJ-45 Ethernet port on the back of the modem.
3. Connect the remaining end of the 10/100 Base-T Ethernet cable into the RJ-45 Ethernet port on the Ethernet Interface Card as shown in Figure 6.

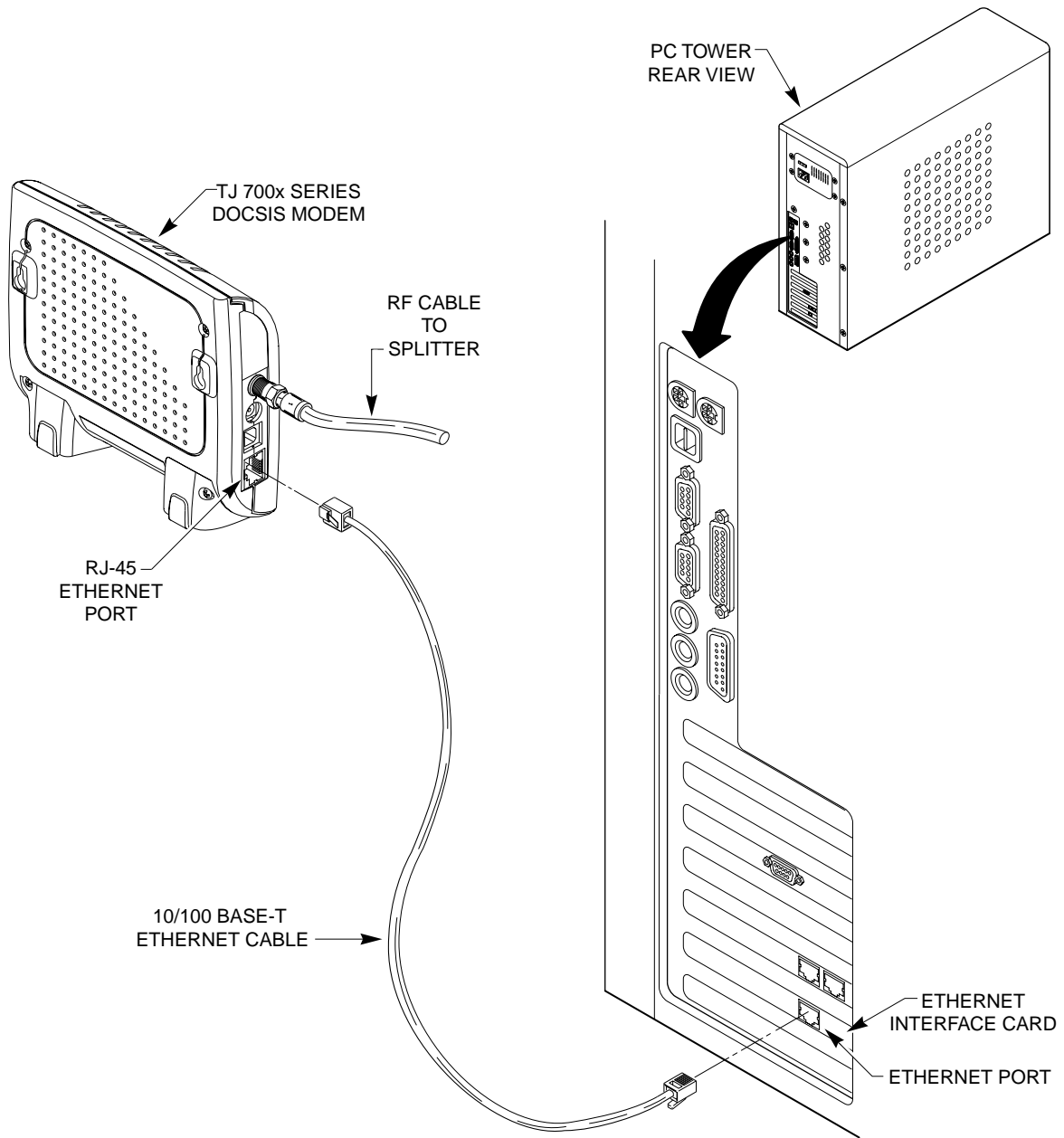
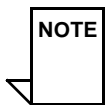

Figure 6 Connecting the 10/100 Base-T Ethernet Cable



NOTE: *Your computer may be a laptop, a desktop model, or a tower model and may look different than the illustration shown in Figure 6.*

Making USB Connections

In order for your computer USB Interface to pass data back and forth to the Terayon TJ 700x Series Modem, you must connect a USB cable to the modem USB port and the USB port on the back of the computer.



IMPORTANT: Before you install the USB cable, you must install a USB driver. Insert the USB Driver CD that came with the modem into your CD-ROM drive and follow the online instructions. You may have to tell the computer what drive your CD-ROM drive is.

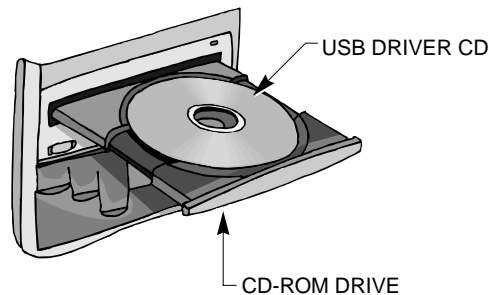

To connect the USB cable, follow these steps:

1. Retrieve the USB cable from the box the modem came in.

Use Figure 1 on page 2 to identify the cable. Notice that the USB cable has two types of connectors, an "A" type, and a "B" type. Figure 7 identifies the connector types.

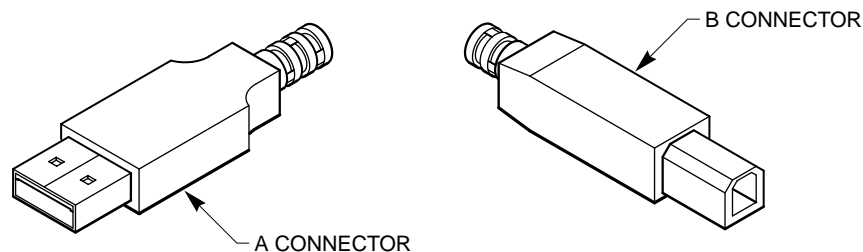

Figure 7 USB Cable Connectors

2. Using Figure 8 on page 11 as a guide, insert the USB cable "B" connector into the USB Serial port on the back of the Terayon TJ 700x Series modem.
3. Insert the USB cable "A" connector into the computer USB Serial port on the back of your computer as shown in Figure 8.

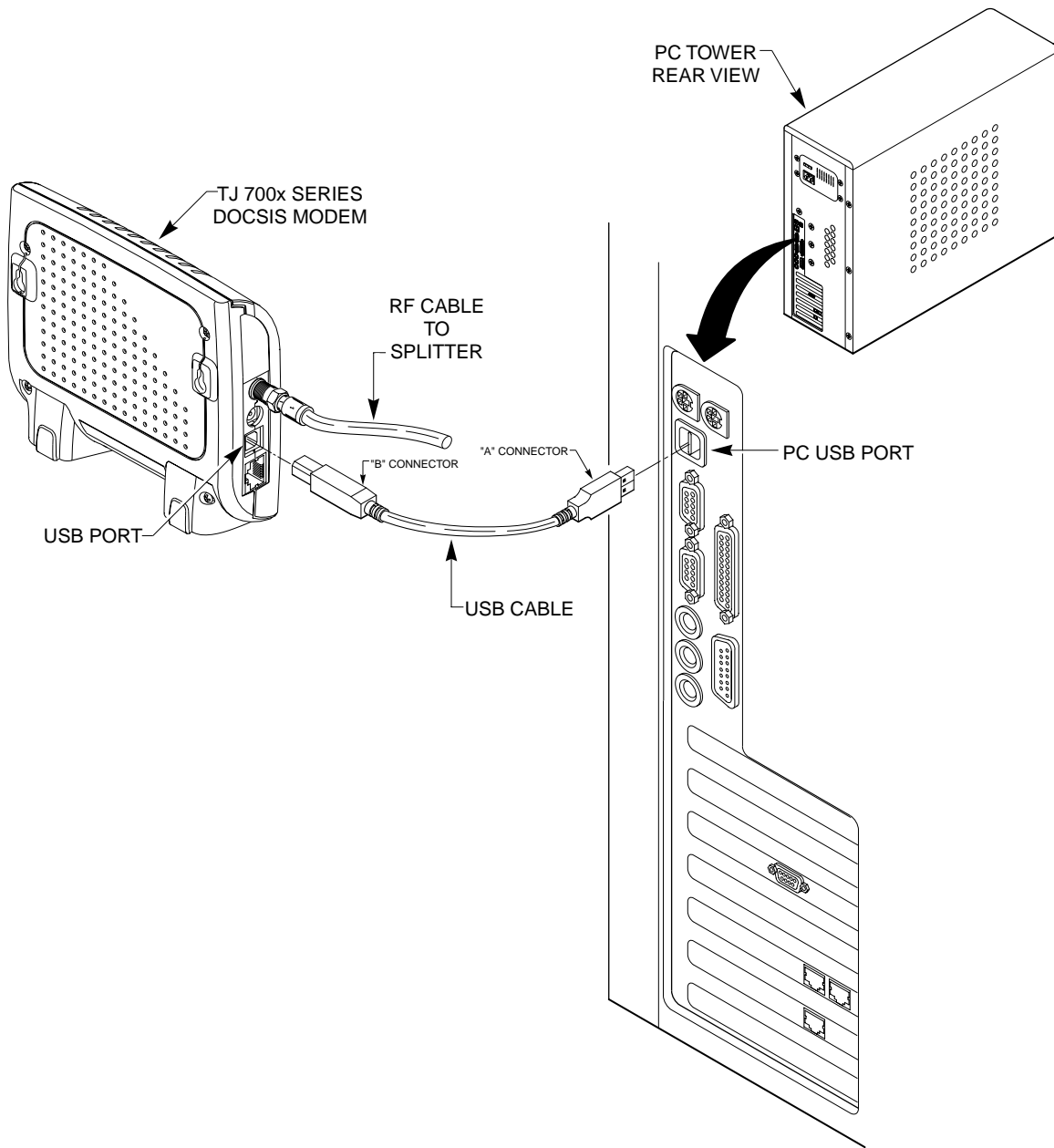
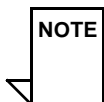

Figure 8 Connecting the USB Cable



NOTE: *Your computer may be a laptop, a desktop model, or a tower model and may look different than the illustration shown in Figure 8.*

Connecting Two PCs to the TJ 700x Series Modem

The Terayon TJ 700x Series modem provides a feature called Ethernet-USB Bridging. This feature allows you to connect two PCs to the modem without having to use an additional hub. Each PC has its own high speed Internet connection and the two PCs can communicate with each other without going through the Internet.

Technical Stuff

One PC connects to the Terayon TJ 700x Series modem via an Ethernet connection (see Figure 9 on page 13). The second PC connects to the modem using a USB connection (see Figure 9 on page 13).

An additional requirement for connecting two PCs to the Terayon TJ 700x Series modem is that your cable operator must provision the modem for two IP addresses. Every computer on the Internet (that includes your two PCs) is assigned a four-part numeric IP address, similar to 127.85.46.9. This IP address identifies the computer to other computers on the net—its sort of like a phone number.

Rather than permanently assigning an IP address to every PC on the cable network, your Internet Service Provider (ISP) or cable operator has a pool of free IP addresses. Every time a PC on the cable network logs onto the Internet, it is assigned a free IP address from the pool. When the PC is finished with its Internet application, the IP address goes back into the pool—it's called Dynamic addressing.

Typically a cable modem like the Terayon TJ 700x Series modem is provisioned to handle just one IP address for one computer. If you connect two PCs to the TJ 700x Series modem, the modem must be provisioned to handle two IP addresses. Your cable operator should have set up your addressing already, so you generally don't have to worry.



IMPORTANT: *If you are going to connect two PCs to your new Terayon TJ 700x Series modem, follow the instructions given for both an Ethernet connection and a USB connection. See “Making Ethernet Connections” on page 8 for instructions on how to install an Ethernet cable. See “Making USB Connections” on page 10 for instructions on how to install a USB cable.*

Just as a reminder, you must install USB drivers on your computer before you install a USB cable.

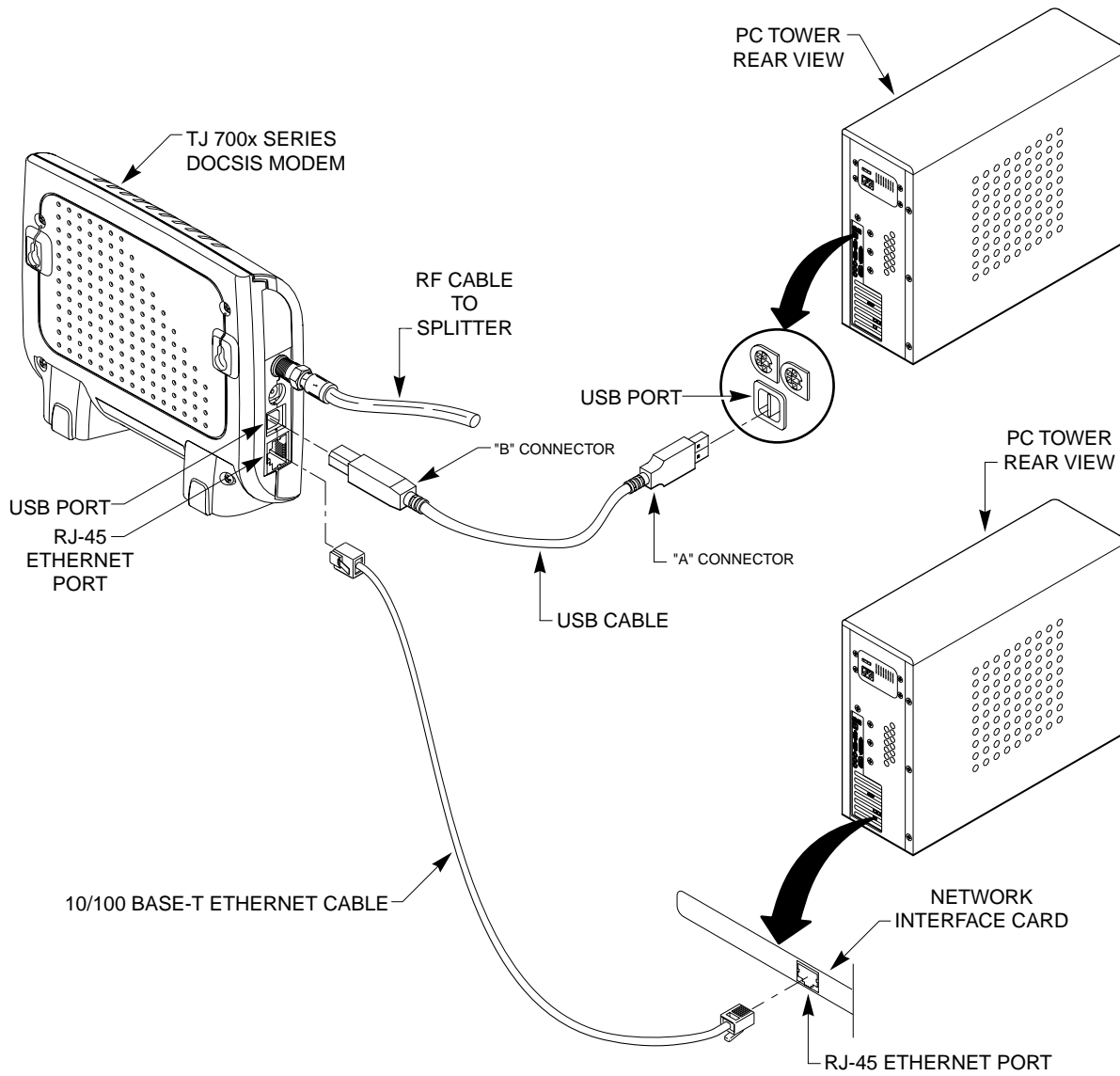

Figure 9 Connecting Two PCs to the Terayon TJ 700x Series Modem

Connecting the Power Adapter and Startup

Power for your cable modem is generated by the Power Adapter unit that comes with the modem. The Power Adapter and power cord shipped with your Terayon TJ 700x Series modem is one of the adapters shown in Figure 10, in compliance with the requirements of your country.

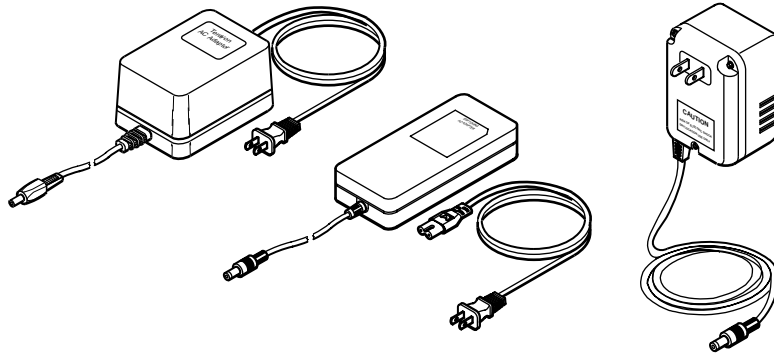

Figure 10 Power Adapters

Connecting the Power Adapter to the Modem

To connect the Power Adapter to the modem, do the following:

1. Remove the modem Power Adapter from the modem cable box.
2. Using Figure 11 on page 15 as a guide, insert the Power Adaptor output connector into the DC Power input jack on the back of the modem.

Starting the Modem

To start operating your new Terayon cable modem, do the following:

1. Plug the Power Adaptor into an appropriate AC power outlet as shown in Figure 11 on page 15.

Once your Terayon cable modem is properly connected and the Power Adapter is connected to an AC power outlet, it will automatically boot-up and start scanning for the active cable modem channel from your cable company server.

2. Verify the Cable and PC LED indicators on the modem front panel are ON.

If the Cable and PC LEDs are ON and not blinking, you have successfully installed your new Terayon cable modem. If the Cable and PC LEDs are not ON or are blinking, See “Troubleshooting” on page 20.



IMPORTANT: When you power up the Terayon DOCSIS cable modem for the first time, it can take up to 10 minutes for the modem to complete its boot-up and scanning sequence. Do not turn modem power off during the boot-up and scanning sequence, unless your cable operator instructs you to do so.

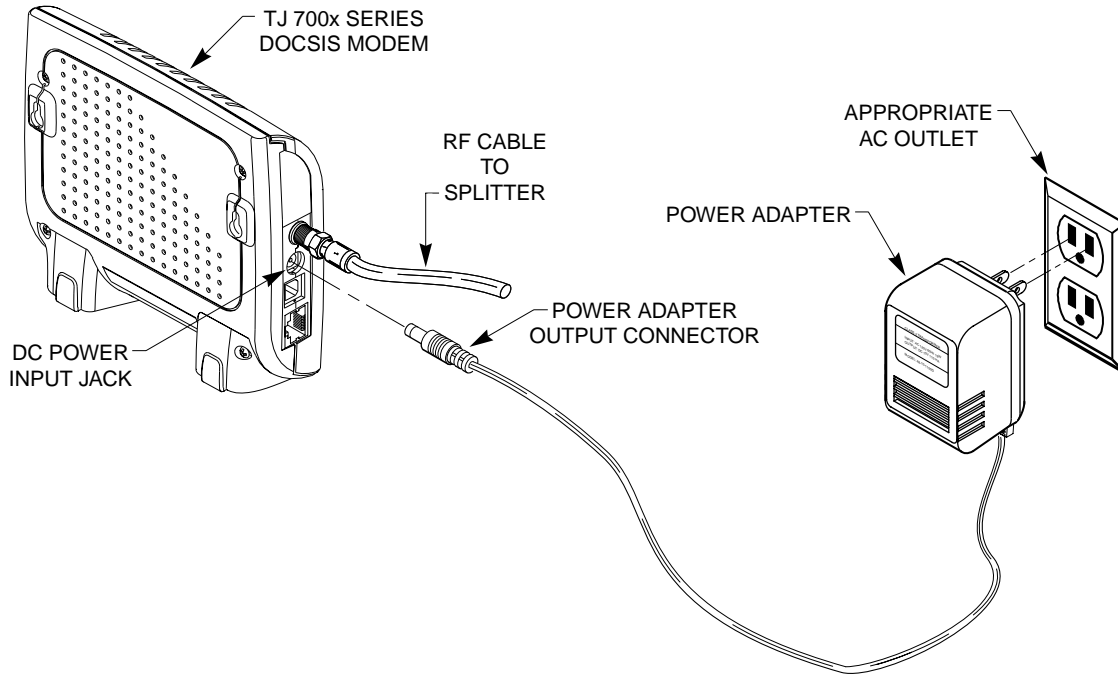
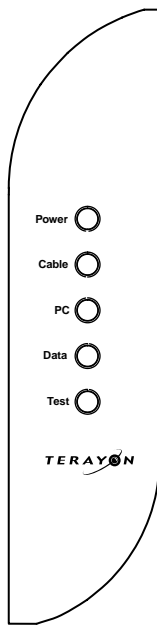

Figure 11 Power Adapter Connections

Reading Your Modem Lights

The indicator LEDs on the front panel of the Terayon cable modem tell you what's happening during a communications session. The table below tells you what each LED indicator means.



LED	Color	Definition
Power	Green	<ul style="list-style-type: none"> • Dark when power is Off. • Solid when power is On.
Cable	Green	<ul style="list-style-type: none"> • Dark for no downstream RF carrier present or power Off. • Flashing slowly for downstream RF carrier present and ranging in process. • Flashing fast when registration is in process, or if flashing fast continuously, network access has been disabled by your cable company. • Solid for modem registration complete and ready to transfer data.
PC	Green	<ul style="list-style-type: none"> • Dark when no carrier is present to or from PC, or power is Off. • Solid when carrier is present to or from PC.
Data	Green	<ul style="list-style-type: none"> • Dark when no data is passing through modem or power is Off. • Flashing when data is passing through modem.
Test	Amber	<ul style="list-style-type: none"> • Dark when initial modem self-test is OK, or power is Off. • Flashing when modem self-test is in process, or when modem is receiving software updates. • Solid when modem fails the initial self-test.

Wall Mounting

To save space on your workstation desk top, you can mount a Terayon TJ 700x Series modem to a wall near your computer or mount it to the workstation desk. Figure 12 shows mounting options. Figure 13 on page 18 illustrates how to mount the modem.

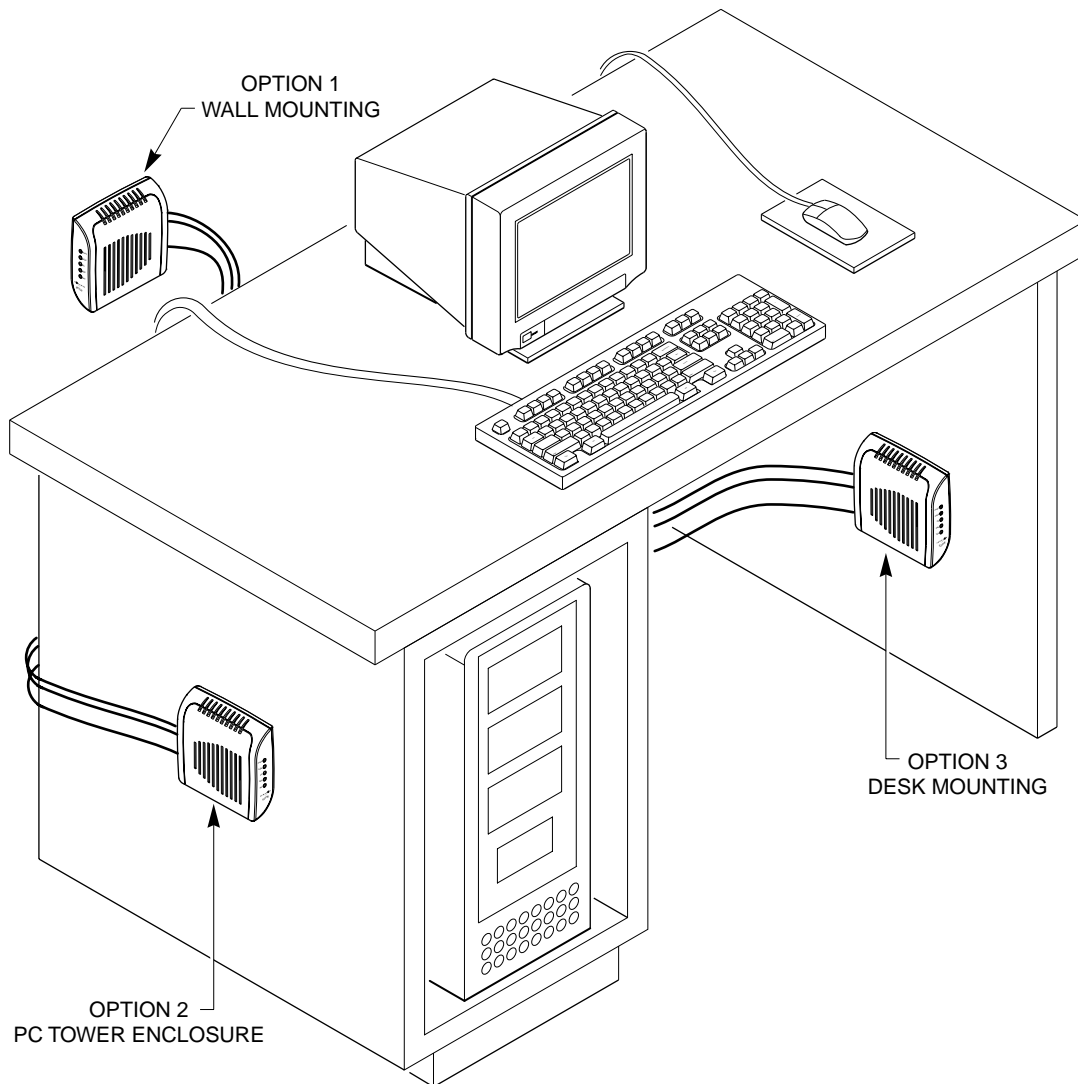

Figure 12 Modem Mounting Options

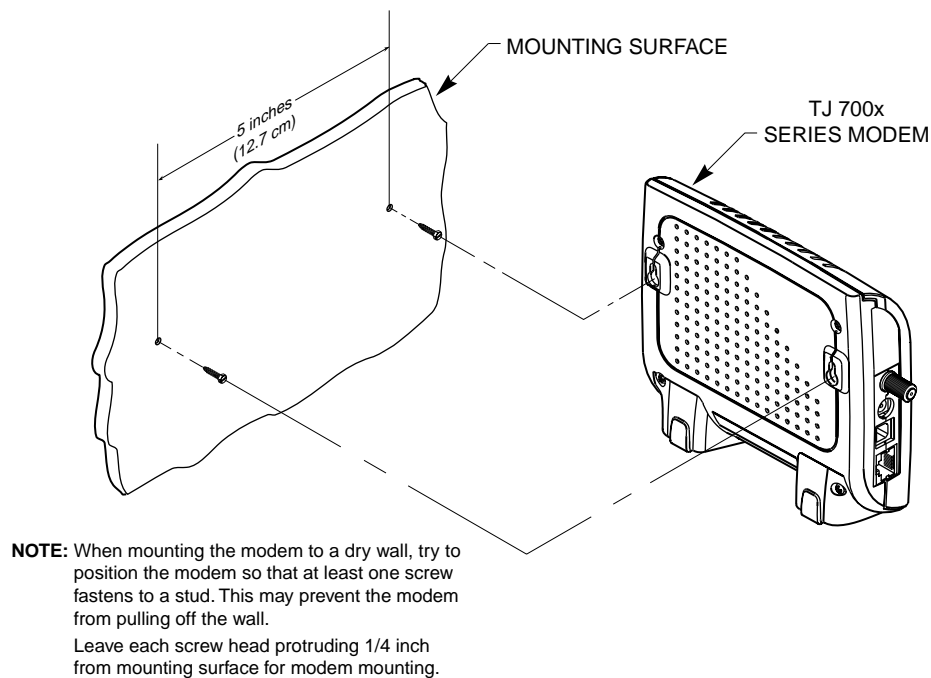

Figure 13 Modem Mounting Diagram

Frequently Asked Questions (FAQs)

Q. *Can I have more than one computer attached to a Terayon modem?*

- A.** Yes, Terayon cable modems provide this capability. Terayon TJ 700x Series modems provide a feature called Ethernet-USB Bridging. It allows you to connect two PCs to the modem without having to use an additional hub. One PC connects to the modem via an Ethernet connection (see “Making Ethernet Connections” on page 8). The second PC connects to the modem using a USB connection (see “Making USB Connections” on page 10). Note that you must arrange for this service with your cable service provider. Some service providers limit the number of computers connected to the modem.

If you have more than two computers you wish to connect to the modem, or your computers are not equipped with USB interfaces, you will need to install a hub into your system. You must also arrange for this service with your cable service provider. As previously mentioned, some service providers limit the number of computers connected to the modem.

Q. *Can I connect the Terayon cable modem to a hub or switch?*

- A.** Yes, you can connect the Terayon cable modem to a hub or switch. Buy a cross-over cable and connect the port labeled 10Base-T on the modem to one of the ports on the hub or switch. Note that many newer hubs and switches have an “uplink” port specifically designed for cascading. Connect this uplink port to your Terayon cable modem and it should work without a cross-over cable. Connect your PC to another available port.



IMPORTANT: *While you may be able to successfully complete a physical connection to a hub or switch indicated by a green PC LED, you cannot obtain additional IP addresses unless your subscription allows for more than one IP address. Contact your cable operator for more information.*

Q. *Can I download new modem software drivers or do something to optimize the modem configuration in order to improve my performance?*

- A.** No, modem configuration and downloading of software drivers can only take place over the network coax cable provided by your cable operator. Note that improving the performance of your cable modem does not give your cable operator access to your computer—your personal privacy and security are not affected.

Q. *If I don't subscribe to cable TV, can I still get a cable modem Internet connection?*

- A.** Yes, but this is a question for your cable service provider or Broadband Service Provider (BSP) and depends on their policies.

Q. *The product specifications define varying data rates, why don't I see those?*

- A.** Your cable operator has the flexibility to set different performance levels to differentiate between different types of subscribers. In general, individual residential subscribers are not allocated the entire channel bandwidth.

Q. *Can I watch TV and surf the Internet at the same time?*

- A.** Yes, neither television or data signals are affected by simultaneous use.

Troubleshooting

Problem:

I cannot access my E-mail or Internet Service.

Possible solution:

Check all connections. Make sure the cable line is securely connected to the cable jack on the back of the modem. Verify the Ethernet or USB cable is securely plugged into both the modem and your network interface card or USB network interface. Make sure your Power Adaptor is properly plugged into both the modem and a wall outlet or surge protector. If your cable modem is properly connected, the Cable and PC indicator lights on the modem front panel should be a solid color.

If the Cable and PC indicator lights (LEDs) are solid green (not blinking), your cable modem is operating properly. Try shutting down and powering off your computer and then turning it back on. This will cause your computer to re-establish communications with your cable company server.

1. If you are using the cable line splitter, try bypassing the splitter by disconnecting it and running a single coaxial cable between the cable modem and your cable wall jack. Try reconnecting after making this change. If reconnecting is successful, you may have a bad splitter.
2. Your network interface card may be malfunctioning. Refer to the Manufacturer's documentation for troubleshooting information.
3. Call your cable company to verify their service is two-way. This modem is designed for use with two-way cable plants. Verify your account is activated.

Problem:

The Cable LED never stops blinking.

Possible Solution:

The signal from your cable company equipment may be too weak or the cable line may not be properly attached to the modem. If the cable line is properly connected to the modem, call your cable company to verify whether or not a weak signal may be the problem.

Problem:

The power on my modem goes on and off sporadically. The Cable LED never stops blinking.

Possible Solution:

You may be using the wrong power supply. Check that the power supply you are using is the one that came with your cable modem. If you cannot connect to the Internet at all, use this checklist to help identify possible problems:

- Make sure your computer and monitor are turned on.
- Make sure all power plugs are completely inserted into their sockets. Your computer and cable modem should be plugged into grounded outlets.
- If you are using a power strip, make sure it is turned on.
- Make sure all data cables are firmly connected at both ends.
- If you still do not have a connection, call your cable service to confirm they have properly set you up for service. If so instructed, reset your modem.

Problem:

I have two PCs connected to the modem, but only one PC can access the Internet.

Possible Solution:

Call your cable company to check your terms of service. Your cable operator may only allow one computer to connect to the modem.

Installation Guide Removal

When you installed your new Terayon DOCSIS Modem, Windows created a shortcut entry, called Terayon DOCSIS Modem, in the Programs section of the Start menu. The shortcut gives you quick access to the modem installation guides for the modem. Windows also created a folder called, Terayon, in the Program Files directory on your computer C drive. This folder contains folders for the installation guides and the USB drivers.

Once you have installed your new modem, you may want to remove the shortcut in the Programs section of the Start menu and remove the Terayon DOCSIS Modem folder from Program Files directory. The easiest way to do this is by using the Add/Remove Programs feature in the Control Panel.

To remove modem installation guides and drivers from your computer, follow these steps:

1. Click the **Start** button, point to **Settings**, then click **Control Panel**.
2. Double click the **Add/Remove Programs** icon in the Control Panel.
3. The Add/Remove Programs Properties dialog box displays.
4. Using the scroll bar at the right side of the dialog box, scroll through the list of programs until you find Terayon DOCSIS Modem.
5. Click on **Terayon DOCSIS Modem**, then click the **Add/Remove** button.
6. Windows deletes the shortcut from the Programs section of the Start menus and deletes the Terayon folder from the Program Files directory.

Technical Support

For service and technical support for your Terayon cable modem, call your cable company.

Visit Our Web Site

<http://www.terayon.com>

