

# User Guide

## SBV5121 VoIP Cable Modem



## Safety and Regulatory Information

**WARNING:** TO PREVENT FIRE OR SHOCK HAZARD, DO NOT EXPOSE THIS PRODUCT TO RAIN OR MOISTURE. THE UNIT MUST NOT BE EXPOSED TO DRIPPING OR SPLASHING. DO NOT PLACE OBJECTS FILLED WITH LIQUIDS, SUCH AS VASES, ON THE UNIT.

**CAUTION:** THIS PRODUCT WAS QUALIFIED UNDER TEST CONDITIONS THAT INCLUDED THE USE OF THE SUPPLIED CABLES BETWEEN SYSTEMS COMPONENTS. TO ENSURE REGULATORY AND SAFETY COMPLIANCE, USE ONLY THE PROVIDED POWER AND INTERFACE CABLES AND INSTALL THEM PROPERLY.

**CAUTION:** DIFFERENT TYPES OF CORD SETS MAY BE USED FOR CONNECTIONS TO THE MAIN SUPPLY CIRCUIT. USE ONLY A MAIN LINE CORD THAT COMPLIES WITH ALL APPLICABLE PRODUCT SAFETY REQUIREMENTS OF THE COUNTRY OF USE.

**CAUTION:** TO REDUCE THE RISK OF FIRE, USE ONLY NO. 26 AWG OR LARGER UL LISTED OR CSA CERTIFIED TELECOMMUNICATION LINE CORD OR NATIONAL EQUIVALENT.

**CAUTION:** INSTALLATION OF THIS PRODUCT MUST BE IN ACCORDANCE WITH NATIONAL WIRING CODES AND CONFORM TO LOCAL REGULATIONS.

**CAUTION:** DO NOT OPEN THE UNIT. DO NOT PERFORM ANY SERVICING OTHER THAN THAT CONTAINED IN THE INSTALLATION AND TROUBLESHOOTING INSTRUCTIONS. REFER ALL SERVICING TO QUALIFIED SERVICE PERSONNEL.

**CAUTION:** CHANGES AND MODIFICATIONS NOT EXPRESSLY APPROVED BY MOTOROLA FOR COMPLIANCE COULD VOID USER'S AUTHORITY TO OPERATE THE EQUIPMENT.

**IMPORTANT SAFETY INSTRUCTIONS:** *When using your telephone equipment, basic safety precautions should always be followed to reduce the risk of fire, electric shock and injury to persons, including the following:*

- Read all of the instructions listed here and/or in the user manual before you operate this equipment. Give particular attention to all safety precautions. Retain the instructions for future reference.
- This device must be installed and used in strict accordance with manufacturer's instructions as described in the user documentation that comes with the product.
- Comply with all warning and caution statements in the instructions. Observe all warning and caution symbols that are affixed to this equipment.
- Do not use this product near water for example, near a bathtub, washbowl, kitchen sink or laundry tub, in a wet basement, or near a swimming pool.
- Do not overload outlets or extension cords, as this can result in a risk of fire or electric shock. Overloaded AC outlets, extension cords, frayed power cords, damaged or cracked wire insulation, and broken plugs are dangerous. They may result in a shock or fire hazard.
- Route power supply cords so that they are not likely to be walked on or pinched by items placed upon or against them. Pay particular attention to cords where they are attached to plugs and convenience receptacles, and examine the point where they exit from the product.
- Place this equipment in a location that is close enough to an electrical outlet to accommodate the length of the power cord.
- Place unit to allow for easy access when disconnecting the power cord of the device from the AC wall outlet.
- Do not connect the plug into an extension cord, receptacle, or other outlet unless the plug can be fully inserted with no part of the blades exposed.
- Place this equipment on a stable surface.
- Postpone cable modem installation until there is no risk of thunderstorm or lightning activity in the area.
- *Avoid using a telephone (other than a cordless type) during an electrical storm.* There may be a remote risk of electric shock from lightning. For added protection for this product during a lightning storm, or when it is left



unattended and unused for long periods of time, unplug it from the wall outlet, and disconnect the cable system. This will prevent damage to the product due to lightning and power surges.

- Do not use the telephone to report a gas leak in the vicinity of the leak.
- It is recommended that the customer install an AC surge protector in the AC outlet to which this device is connected. This is to avoid damaging the equipment by local lightning strikes and other electrical surges.
- Do not cover the device, or block the airflow to the device with any other objects. Keep the device away from excessive heat and humidity and keep the device free from vibration and dust.
- Wipe the unit with a clean, dry cloth. Never use cleaning fluid or similar chemicals. Do not spray cleaners directly on the unit or use forced air to remove dust.
- Avoid damaging the cable modem with static by touching the coaxial cable when it is attached to the earth-grounded coaxial cable TV wall outlet.
- Always first touch the coaxial cable connector on the cable modem when disconnecting or re-connecting USB or Ethernet cable from the cable modem or the user's PC.
- Operate this product only from the type of power source indicated on the product's marking label. If you are not sure of the type of power supplied to your home, consult your dealer or local power company.
- Use only the power cord and batteries indicated in this manual. Do not dispose of batteries in a fire. They may explode. Check with local codes for possible special disposal instructions.
- Disconnect TNV circuit connector before removing cover.
- Do not use the telephone to report a gas leak in the vicinity of the leak.
- Upon completion of any service or repairs to this product, ask the service technician to perform safety checks to determine that the product is in safe operating condition.

SAVE THESE INSTRUCTIONS

## Caring for the Environment by Recycling



When you see this symbol on a Motorola product, do not dispose of the product with residential or commercial waste.

### Recycling your Motorola Equipment

Please do not dispose of this product with your residential or commercial waste. Some countries or regions, such as the European Union, have set up systems to collect and recycle electrical and electronic waste items. Contact your local authorities for information about practices established for your region. If collection systems are not available, call Motorola Customer Service for assistance.

## Important VoIP Service Information



Any services provided through this equipment:

- Are not intended to replace or be a substitute for primary line voice services or Plain Old Telephone Service (POTS).
- Are not meant to provide guaranteed 911 or E911 services or to permit access to 411 directory assistance services.

**IMPORTANT:** When using this VoIP device, you CANNOT make any calls, including an emergency call, and E911 location services WILL NOT be available, under the following circumstances:

- Your broadband ISP connection goes down, is lost or otherwise fails.
- You lose electrical power.

When using this VoIP device, you may be able to make an emergency call to an operator, but E911 location services may not be available under the following circumstances:

- You have changed the physical address of your VoIP device, and you did not update or otherwise advise your VoIP service provider of this change.
- You are using a non-U.S. telephone number.
- There are delays in making your location information available in or through the local automatic location information database.

Note: Your service provider, not Motorola, is responsible for the provision of VoIP telephony services through this equipment. Motorola shall not be liable for, and expressly disclaims, any direct or indirect liabilities, damages, losses, claims, demands, actions, causes of action, risks or harms arising from or related to the services provided through this equipment.

Be sure that the outside cable system is grounded, so as to provide some protection against voltage surges and built-up static charges. Article 820-20 of the NEC (Section 54, Part I of the Canadian Electrical Code) provides guidelines for proper grounding and, in particular, specifies the CATV cable ground shall be connected in the grounding system of the building, as close to the point of cable entry as practical.

### FCC Compliance Class B Digital Device

This device complies with part 15 of the FCC Rules. Operation is subject to the following two conditions: (1) This device may not cause harmful interference, and (2) this device must accept any interference received, including interference that may cause undesired operation.

Note: This equipment has been tested and found to comply with the limits for a Class B digital device, pursuant to part 15 of the FCC Rules. These limits are designed to provide reasonable protection against harmful interference in a residential installation. This equipment generates, uses, and can radiate radio frequency energy and, if not installed and used in accordance with the instructions, may cause harmful interference to radio communications. However, there is no guarantee that interference will not occur in a particular installation. If this equipment does cause harmful interference to radio or television reception, which can be determined by turning the equipment off and on, the user is encouraged to try to correct the interference by one or more of the following measures:

- Reorient or relocate the receiving antenna.
- Increase the separation between the equipment and receiver.
- Connect the equipment into an outlet on a circuit different from that to which the receiver is connected.
- Consult the dealer or an experienced radio/TV technician for help.

### Canada - Industry Canada (IC)

This Class B digital device complies with Canadian ICES-003.

Cet appareil numérique de la classe B est conforme à la norme NMB-003 du Canada.



**FCC Declaration of Conformity**

According to 47CFR, Parts 2 and 15 for Class B Personal Computers and Peripherals; and/or CPU Boards and Power Supplies used with Class B Personal Computers, Motorola, Inc. Connected Home Solutions, 101 Tournament Drive, Horsham, PA 19044, 1-215-323-1000, declares under sole responsibility that the product identifies with 47CFR Part 2 and 15 of the FCC Rules as a Class B digital device. Each product marketed is identical to the representative unit tested and found to be compliant with the standards. Records maintained continue to reflect the equipment being produced can be expected to be within the variation accepted, due to quantity production and testing on a statistical basis as required by 47CFR 2.909. Operation is subject to the following two conditions: (1) this device may not cause harmful interference, and (2) this device must accept any interference received, including interference that may cause undesired operation. The above named party is responsible for ensuring that the equipment complies with the standards of 47CFR, Paragraph 15.101 to 15.109.

**International Declaration of Conformity**

We,  
Motorola, Inc.  
Connected Home Solutions Business  
101 Tournament Drive  
Horsham, PA, U.S.A

declare under our sole responsibility that the  
SBV5121 Series

to which the declaration relates is in conformity with one or more of the following standards:

EN55022 EN55024 EN60950-1 EN61000-3-2 EN61000-3-3  
CISPR 22 CISPR 24 IEC 60950-1

the following provisions of the Directive(s) of the Council of the European Union:

EMC Directive Low Voltage Directive 73/23/EEC  
89/336/EEC  
Directive 93/68/EEC

Models	Standards
SBV5121, SBV5121 Diagnostic	FCC Part 15, ICES-003, UL60950-1, CAN/CSA-C22.2 No. 60950-1
SBV5121i, SBV5121E, SBV5121 Diagnostic, SBV5121E Diagnostic	EN55022, EN55024, CISPR 22, CISPR 24, EN60950-1, IEC60950-1, EN61000-3-2, EN61000-3-3

**Regulatory, Safety, Software License, and Warranty Information Card**

This product is provided with a separate *Regulatory, Safety, Software License, and Warranty Information* card. If one is not provided with this product, please ask your service provider or point-of-purchase representative, as the case may be.

- THIS PRODUCT IS IN COMPLIANCE WITH ONE OR MORE OF THE STANDARDS LISTED ON THE *REGULATORY, SAFETY, SOFTWARE LICENSE, AND WARRANTY INFORMATION CARD*. NOT ALL STANDARDS APPLY TO ALL MODELS.
- NO WARRANTIES OF ANY KIND ARE PROVIDED BY MOTOROLA WITH RESPECT TO THIS PRODUCT, EXCEPT AS STATED ON THE *REGULATORY, SAFETY, SOFTWARE LICENSE, AND WARRANTY INFORMATION CARD*. MOTOROLA'S WARRANTIES DO NOT APPLY TO PRODUCT THAT HAS BEEN REFURBISHED OR REISSUED BY YOUR SERVICE PROVIDER.



Copyright © 2006 by Motorola, Inc.

All rights reserved. No part of this publication may be reproduced in any form or by any means or used to make any derivative work (such as translation, transformation or adaptation) without written permission from Motorola, Inc.

Motorola reserves the right to revise this publication and to make changes in content from time to time without obligation on the part of Motorola to provide notification of such revision or change. Motorola provides this guide without warranty of any kind, either implied or expressed, including, but not limited to, the implied warranties of merchantability and fitness for a particular purpose. Motorola may make improvements or changes in the product(s) described in this manual at any time.

MOTOROLA and the Stylized M Logo are registered in the US Patent & Trademark Office. Microsoft, Windows, Windows Me, and Windows NT are registered trademarks and Windows XP is a trademark of Microsoft Corporation. Microsoft Windows screen shots are used by permission of Microsoft Corporation. DOCSIS is a registered trademark of CableLabs. Linux is a registered trademark of Linus Torvalds. Solaris, Java, and all Java-based marks trademarks or registered trademarks of Sun Microsystems, Inc. in the United States and other countries. Acrobat Reader is a registered trademark of Adobe Systems, Inc. Navigator is a registered trademark of Netscape Communications Corporation. UNIX is a registered trademark of the Open Group in the United States and other countries. All other product or service names are the property of their respective owners. © Motorola, Inc. 2006.

## Contents

<b>Safety and Regulatory Information</b> .....	<b>ii</b>
Important VoIP Service Information .....	iv
<b>Introduction</b> .....	<b>1</b>
SBV5121 Cable Modem .....	1
SBV5121 VoIP Telephone Service .....	1
Telephone Features Supported by the SBV5121 .....	2
Top and Front Panel .....	3
Rear Panel .....	4
<b>Before You Begin</b> .....	<b>4</b>
Precautions .....	5
Signing Up for Service .....	6
<b>Computer System Requirements</b> .....	<b>7</b>
Ethernet Card .....	7
USB Connection .....	7
<b>Installation and Configuration</b> .....	<b>8</b>
Cabling and Startup for a Single User .....	8
Setting Up a USB Driver .....	10
Setting Up a USB Driver in Windows 98 Second Edition .....	11
Setting Up a USB Driver in Windows 2000 .....	15
Setting Up a USB Driver in Windows Me .....	18
Setting Up a USB Driver in Windows XP .....	19
Configuring TCP/IP .....	20
Configuring TCP/IP in Windows 98 Second Edition, or Windows Me .....	20
Configuring TCP/IP in Windows 2000 .....	23
Configuring TCP/IP in Windows XP .....	26
Verifying the IP Address .....	30
Verifying the IP Address in Windows 98 Second Edition, or Windows Me .....	30
Verifying the IP Address in Windows 2000 or Windows XP .....	31
Renewing Your IP Address .....	32
<b>Cabling for Multiple Users</b> .....	<b>33</b>
Ethernet and USB .....	33
Ethernet .....	34
<b>Troubleshooting</b> .....	<b>35</b>
Front-Panel Lights and Error Conditions .....	36
Removing the USB Driver from Windows 98 Second Edition or Windows Me .....	37
Removing the USB Driver from Windows 2000 .....	38
Removing the USB Driver from Windows XP .....	40
Running the Motorola USB Driver Removal Utility .....	43
<b>Contact Us</b> .....	<b>45</b>
<b>Frequently Asked Questions</b> .....	<b>45</b>
<b>Glossary</b> .....	<b>47</b>

**Software License** ..... **49**



## Introduction

Congratulations on your new Motorola® SBV5121 Voice over Internet Protocol (VoIP) cable modem! It provides high-speed access to the Internet and other online services and connections for up to two telephone lines.

### SBV5121 Cable Modem

Your VoIP cable modem transmits and receives data much faster than traditional dial-up or DSL (digital subscriber line) modems. It lets you enjoy surfing the Web without the long wait. Because many network and other factors can affect performance, the actual speed will vary.

Unlike a dial-up modem, your SBV5121 VoIP cable modem is always online. Just open your browser and surf!

You can use your high-speed, upgradeable VoIP cable modem to connect one or more computers in your home or business to the Internet. You can connect:

- A single computer equipped with a Universal Serial Bus (USB) port directly to the USB port on the SBV5121 VoIP cable modem
- A single computer equipped with an Ethernet adapter directly to the Ethernet port on the SBV5121 VoIP cable modem
- Two computers, one to the USB port and one to the Ethernet port
- Up to 31 computers to a single SBV5121 VoIP cable modem using an Ethernet hub, as shown in “Cabling for Multiple Users” on page 33

*For easiest set-up, use the Installation Assistant on the SBV5121 VoIP Cable Modem CD-ROM.*

### SBV5121 VoIP Telephone Service

The SBV5121 also provides telephone service through your cable connection with the same features as your traditional phone service. You can connect up to two standard telephone lines using your SBV5121 VoIP cable modem, supporting:

- Local and long-distance calling
- Standard features like call hold and mute, caller ID, speed dial, call forwarding, call waiting, call return, three-way calling, and voice mail
- Telephone modem and fax support
- Software upgrades over the network to provide new or improved services

#### Caution



Use only a standard telephone. Digital phones used in many businesses that connect to a PBX (private branch exchange) do not operate with the SBV5121.

An external backup power supply may be connected to your SBV5121 that provides standby power for your VoIP telephone service if AC power is lost. Please contact your service provider for additional information about the Motorola PB1000 Battery Backup Power Supply.

## Telephone Features Supported by the SBV5121

The SBV5121 supports the telephone features listed below. Some features listed may not be available on your telephone. These features are enabled and disabled on your VoIP telephone modem by your service provider.

- Standard two-wire telephone connection for voice, fax, and telephone modem operation. The connection to the telephone equipment is made with a standard RJ-11 jack and plug.
- Re-dial number
- Speed dial
- Call forwarding
- Call hold and mute
- Call return
- Call waiting
- Caller ID
- Caller ID block
- Three-way calling
- Voice mail
- Telephony Devices for the Disabled (TDD)
- On hook, off hook detection
- Operator barge-in
- Standard call progress signals
- Dial-tone stutter
- Dial-tone busy
- Fast-busy stutter dial-tone
- No support for pulse-dial equipment

## Top and Front Panel

For added security you can press the Standby button **(1)** to suspend your Internet connection. No data is transmitted or received from the Internet when the Standby light is on. All other front-panel lights turn off until you press the Standby button again, except for Tel 1 and Tel 2. Standby does not affect your telephone service. Voice service still operates when Standby is on.

*The model number on your VoIP cable modem may be different than in the illustrations and screen images in this guide.*

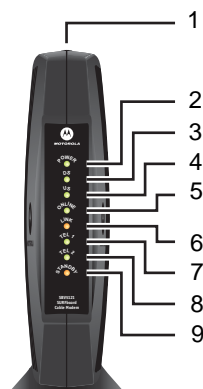

The lights provide information about power, communications, and errors:

Key	Light	Flashing	On
2	<b>Power</b>	Startup diagnostics in progress	The VoIP cable modem is powered on.
3	<b>DS (downstream)</b>	Scanning for a receive ( <b>downstream</b> ) channel connection	The downstream channel is connected.
4	<b>US (upstream)</b>	Scanning for a send ( <b>upstream</b> ) channel connection	The upstream channel is connected.
5	<b>Online</b>	Scanning for a network connection	The startup process is complete.
6	<b>Link</b>	Transmitting or receiving data	A device, such as a computer or hub, is connected to the USB or Ethernet connectors on the back panel.
7	<b>Tel 1</b>	Connected and activated, telephone is off-hook (in use).	Connected and activated, the telephone is on-hook (not in use).
8	<b>Tel 2</b>	Connected and activated, telephone is off-hook (in use).	Connected and activated, the telephone is on-hook (not in use).
9	<b>Standby</b>	This light does not flash	Internet service is blocked because the Standby button was pressed. If this light is on, all other lights are off, except for Tel 1 and Tel 2.

During normal operation, the Power, Receive, Send, and Online lights are on and the Link light flashes when the VoIP cable modem is transferring data.

## Rear Panel

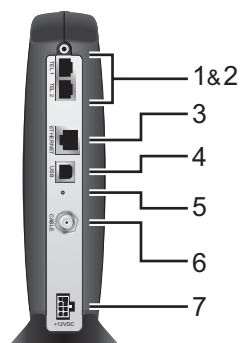





The rear panel provides cabling connectors and the power receptacle:

Key Item	Description
1 & 2 Tel 1 and Tel 2	Provide connections for two telephone lines.
3 ETHERNET	Provides a connection to Ethernet equipped computers using a cable terminated with an RJ-45 connector.
4 USB	Provides a connection to USB equipped computers.
5 Reset	If you experience a problem, you can push this recessed button to reset the VoIP cable modem (see "Troubleshooting" on page 35). Resetting may take some time (5 to 30 minutes) because the VoIP cable modem must find and lock on the appropriate communications channels.
6 CABLE	Provides a connection to the coaxial cable (coax) outlet.
7 +12VDC	Provides power to the VoIP cable modem.

## Before You Begin

Before you begin the installation, check that you received the following items with your VoIP cable modem:

Item	Description
Power adapter or cable	 <p>Connects to:</p> <ul style="list-style-type: none"> <li>the AC power outlet</li> <li>to a UPS</li> </ul>
10/100Base-T Ethernet cable	 <p>Connects to the Ethernet port</p>
USB cable	 <p>Connects to the USB port</p>
Phone wire	 <p>Connects the telephone to the cable system to provide telephone service</p>
SBV5121 VoIP Cable Modem CD-ROM	 <p>Contains the User Guide and USB drivers</p>

You will need 75-ohm [coaxial cable](#) with [F-type connectors](#) to connect your VoIP cable modem to the nearest cable outlet. If a TV is connected to the cable outlet, you may need a 5-900 MHz RF [splitter](#) and a total of three coaxial cables to connect both the TV and the VoIP cable modem. The coaxial cable and RF splitter are available at consumer electronic stores. To connect your VoIP cable modem to an Ethernet hub, see the network description in [“Cabling for Multiple Users”](#) on page 33. Check the documentation provided with your hub.

**Caution**

	<p>This product is for indoor use only. Do not route the USB, Ethernet, or telephone cables outside of the building. Exposure of the cables to lightning could create a safety hazard and damage the product.</p>
---	---

**Precautions**

Postpone VoIP cable modem installation until there is no risk of thunderstorm or lightning activity in the area.

To avoid damaging the VoIP cable modem with static electricity:

- Always first connect the coaxial cable to the grounded cable TV wall outlet.
- Before you connect or disconnect the USB or Ethernet cable from your VoIP cable modem or PC, always touch the coaxial cable connector on the VoIP cable modem to release any static charges.

**To avoid damaging your VoIP cable modem or PC with static electricity:**



To prevent overheating the VoIP cable modem, do not block the ventilation holes.

Do not open the VoIP cable modem. Refer all service to your cable provider.

Wipe the VoIP cable modem with a clean, dry cloth. Never use cleaning fluid or similar chemicals. Do not spray cleaners directly on the unit or use forced air to remove dust.

**Caution**

	<p>Contact your cable provider before connecting your VoIP cable modem to your existing telephone wiring. Do not connect the telephone wire to a traditional telephone (<a href="#">PSTN</a>) service.</p>
---	--

## Signing Up for Service

You must sign up with a cable provider to access the Internet and other online services.

To activate your service, call your local cable provider.

To receive data service, you need to provide the **MAC address** printed on the bar code label marked **CM HFC MAC ID** on the bottom of the cable modem. You can record it here:

00 : \_\_\_\_\_ : \_\_\_\_\_ : \_\_\_\_\_ : \_\_\_\_\_ : \_\_\_\_\_

To receive telephone service, you need to provide the **MAC address** printed on the bar code label marked **MTA MAC ID** on the bottom of the cable modem. You can record it here:

00 : \_\_\_\_\_ : \_\_\_\_\_ : \_\_\_\_\_ : \_\_\_\_\_ : \_\_\_\_\_

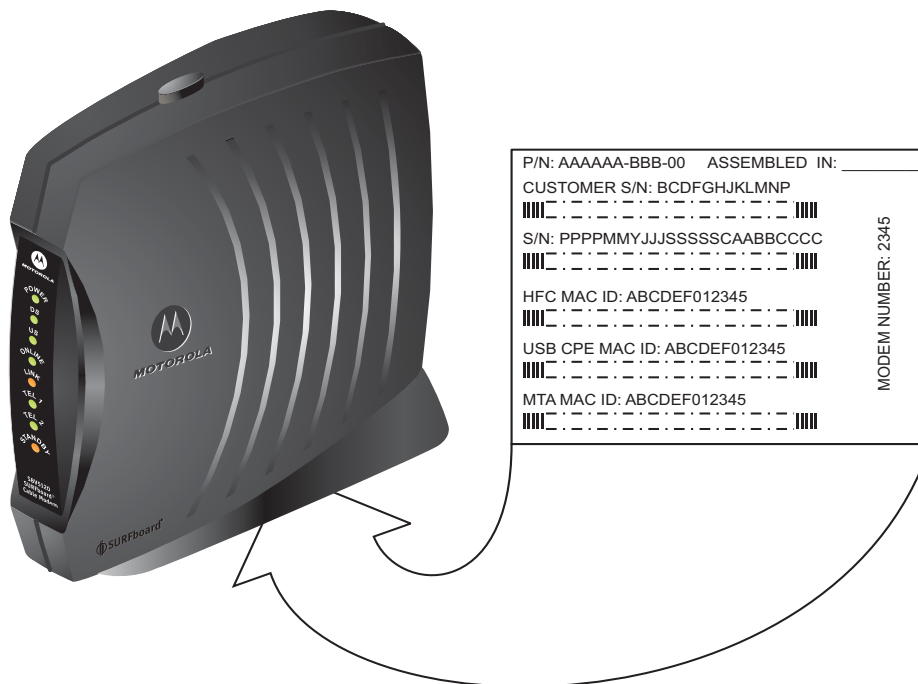

You should ask your cable provider the following questions:

- Do you have any special system requirements?
- When can I begin to use my VoIP cable modem?
- Are there any files I need to [download](#) after I am connected?
- Do I need a user name or password to access the Internet or use e-mail?

---

## Computer System Requirements

You can use any Web browser, such as Microsoft® Internet Explorer or Netscape Navigator®, with your SBV5121 VoIP cable modem.

For Microsoft Windows computers, the Installation Assistant application automatically checks your system configuration. You can start the Installation Assistant from the Main Menu on the *SBV5121 VoIP Cable Modem* CD-ROM.

Your SBV5121 VoIP cable modem is compatible with Microsoft Windows®, Macintosh®, and UNIX® computers. Windows® 95 is not supported by the SBV5121.

You must have the latest version of your operating system installed with all current service packs and patches.

### Ethernet Card

You can use the Ethernet connection with any version of Windows except Windows® 95 on a computer equipped with a 10Base-T or 10/100Base-T Ethernet card. The Ethernet connection also supports Macintosh, UNIX, or Linux® computers equipped with a 10Base-T or 10/100Base-T Ethernet card.

The original version of Windows® 98, Windows® NT, UNIX, Linux, or Macintosh computers must use the Ethernet connection.

If you use an Ethernet card, it must be installed in your computer before you install the VoIP cable modem. If it is not installed, follow the installation instructions provided with your Ethernet card.

### USB Connection

You can use the USB connection with any PC running Windows® 98 Second Edition, Windows® 2000, Windows Me®, or Windows XP™ that has a USB interface. The USB connection requires special USB driver software that is supplied on the *SBV5121 VoIP Cable Modem* CD-ROM.

You can upgrade your USB drivers from our [Downloads](http://broadband.motorola.com/noflash/usb_drivers.asp) page [http://broadband.motorola.com/noflash/usb\\_drivers.asp](http://broadband.motorola.com/noflash/usb_drivers.asp).

## Installation and Configuration

To install and configure your VoIP cable modem for a single PC running Microsoft Windows, we recommend using the Installation Assistant. You can start the Installation Assistant from the Main Menu on the *SBV5121 VoIP Cable Modem* CD-ROM. In most cases, the Installation Assistant automatically configures your VoIP cable modem.

Otherwise, to install and configure your VoIP cable modem:

- 1 Connect the cables as described for your situation:
  - “Cabling and Startup for a Single User” on page 8
  - “Cabling for Multiple Users” on page 33
- 2 If you are using the USB port *only*, go to “Setting Up a USB Driver” on page 10. *Ethernet users can skip this step.*
- 3 Configure TCP/IP and verify the IP address for your computer as described for your situation:
  - For Windows computers, see “Configuring TCP/IP” on page 20
  - Refer to your Macintosh or UNIX user manual for information regarding TCP/IP and IP address configuration.

### Cabling and Startup for a Single User

Allow some time (5 to 30 minutes) to power up the first time because the SBV5121 VoIP cable modem must find and lock on the appropriate channels for communications.

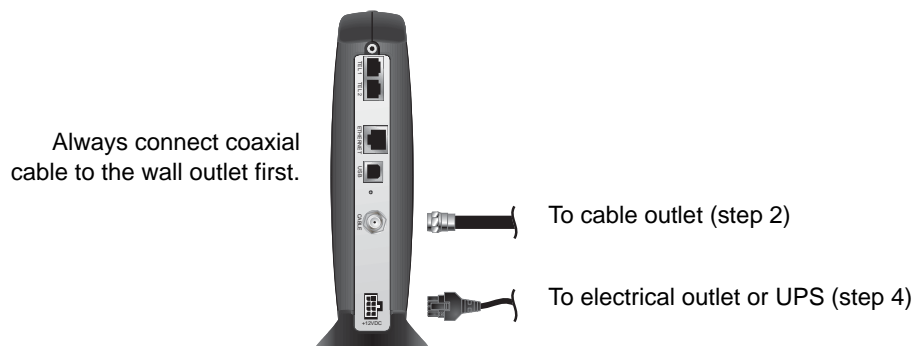

- 1 Be sure your computer is on and the VoIP cable modem is unplugged.
- 2 Connect one end of the coaxial cable to the cable outlet or splitter. Connect the other end of the coaxial cable to the CABLE connector on the VoIP cable modem. *Hand-tighten the connectors to avoid damaging them.*
- 3 Insert the *SBV5121 VoIP Cable Modem* CD-ROM into your CD-ROM drive.
- 4 If you are using an AC power adapter, plug the adapter into the +12VDC connector on the VoIP cable modem and an unswitched AC electrical outlet.

or

If you are using an Uninterruptible Power Supply (UPS), plug the power cord into the +12VDC connector on the VoIP cable modem and into the UPS. Plug the UPS into an unswitched AC electrical outlet.

This turns on the SBV5121 VoIP cable modem. You do not need to unplug it when not in use.



- 5 Check that the lights on the front of the VoIP cable modem cycle through this sequence:
  - Power flashes during the self-test and changes to solid green when the self-test is successfully complete.
  - Receive flashes while scanning for the receive ([downstream](#)) channel and changes to solid green when it is connected.
  - Send flashes while scanning for the send ([upstream](#)) channel and changes to solid green when it is connected.
  - Online flashes while the VoIP cable modem downloads configuration data and changes to solid green when the download is complete.
- 6 Connect your computer to the VoIP cable modem using USB or Ethernet:

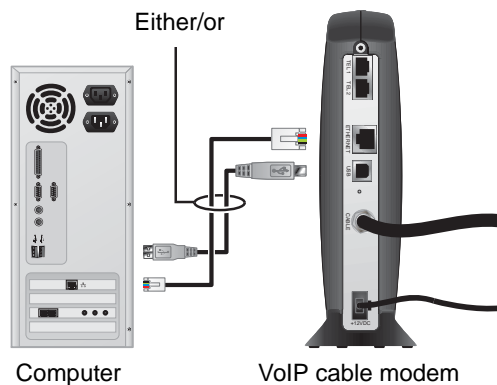

**USB:** Be sure the SBV5121 VoIP Cable Modem CD-ROM is inserted in your CD-ROM drive. Perform the appropriate procedure for [Setting Up a USB Driver](#) for your Windows version. Connect the USB cable to the USB port on the VoIP cable modem. Connect the other end to the USB port on your PC.

**Ethernet:** Connect the provided straight-through Ethernet cable to the Ethernet connector on the VoIP cable modem. Connect the other end to the Ethernet port on your computer. *Ethernet users do not need to set up USB.*

- 7 Perform the procedures for ["Configuring TCP/IP"](#) on page 20.

- 8 To connect the telephone line, plug a phone wire into the Tel 1 connector. You can also connect a second telephone line to the Tel 2 connector.

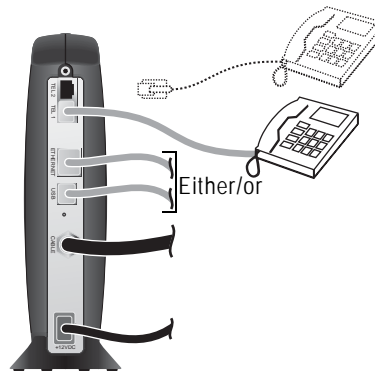

**Caution!**



To reduce the risk of fire, use only No. 26 or larger UL Listed or CSA Certified Telecommunication Line Cord to connect a telephone line to your SBV5121 VoIP cable modem.

Do not connect *both* the Ethernet and USB cables to the same computer. Connect to either Ethernet or USB.

Contact your cable provider before connecting your VoIP cable modem to your existing telephone wiring. Do not connect the telephone wire to a traditional telephone (PSTN) service.

Be sure the phone connectors are neither connected together nor connected to wall jacks on the same network.

**Setting Up a USB Driver**

The following subsections describe setting up a USB driver. Before connecting a PC to the USB port, perform the appropriate procedure for your Windows version:

- [“Setting Up a USB Driver in Windows 98 Second Edition”](#) on page 11
- [“Setting Up a USB Driver in Windows 2000”](#) on page 15
- [“Setting Up a USB Driver in Windows Me”](#) on page 18
- [“Setting Up a USB Driver in Windows XP”](#) on page 19

When you finish setting up the USB driver, you can continue with [“Configuring TCP/IP”](#) on page 20.

The SBV5121 VoIP cable modem USB driver does not support Macintosh or UNIX computers. For those systems, you can connect through Ethernet *only*.

**Caution!**



*Be sure the SBV5121 VoIP Cable Modem CD-ROM is inserted in the CD-ROM drive before you plug in the USB cable.*

## Setting Up a USB Driver in Windows 98 Second Edition

- 1 *Insert the SBV5121 VoIP Cable Modem CD-ROM in the CD-ROM drive.* This CD contains the USB drivers and must be inserted and read by the PC before you connect the VoIP cable modem to the PC.
- 2 Connect the VoIP cable modem to your computer with a USB cable. For further instructions, see [“Cabling and Startup for a Single User”](#) on page 8. A few seconds after you complete the USB connection, the Add New Hardware Wizard window is displayed:



- 3 Click **Next**. The following window is displayed:



- 4 Be sure “Search for the best driver for your device” is selected and click **Next**. The following window is displayed:



- 5 Be sure “CD-ROM drive” is the only box selected. Click **Next**.

The message “Please wait while Windows searches for a new driver for this device” is displayed.

If your computer successfully locates the driver, skip to step 8.

If your computer does not locate the driver, the previous window is displayed again.

- 6 Select **Specify a location** and type the location of your CD-ROM drive.



To load the driver successfully, you may need to click **Browse** to manually select the **NetMotCM.sys** file from the CD-ROM.

7 Click **Next**. The following window is displayed:

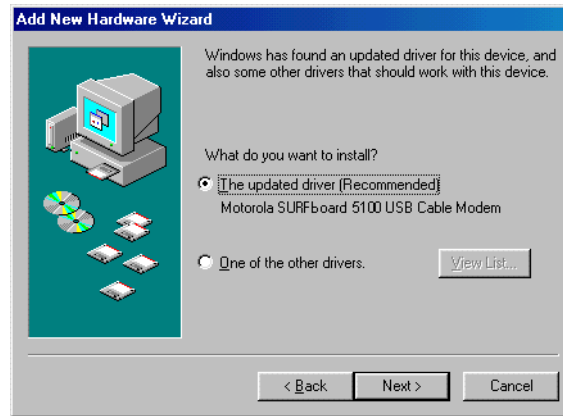

8 Select **The updated driver...** and click **Next**.

If this window is not displayed, verify that the *SBV5121 VoIP Cable Modem* CD-ROM is properly inserted in the CD-ROM drive. If you still cannot find the correct driver file, click **Cancel** to cancel the installation and perform the procedure for [“Removing the USB Driver from Windows 98 Second Edition or Windows Me”](#) on page 37. Then repeat this procedure.

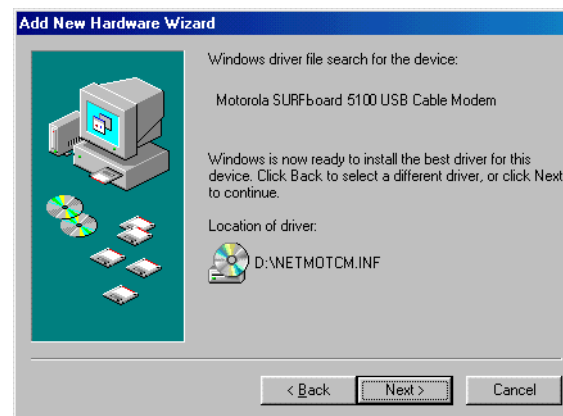

Although your VoIP cable modem model number may be different than in the images in this guide, the procedure is the same.

- 9 After the window shown under step 8 is displayed, click **Next**.

If a window with the message *Copying Files...* displays and asks for your CD-ROM drive, type your CD-ROM drive *letter* (for example, "D:") and click **OK**.

If an Insert Disk window similar to the following is displayed, Windows system files are needed to complete the installation. To install the files, insert your Windows 98 Second Edition CD-ROM in the CD-ROM drive and click **OK**.



After all the necessary files are loaded, the following window is displayed confirming a successful installation.



- 10 Click **Finish**. The Systems Settings Change window is displayed:

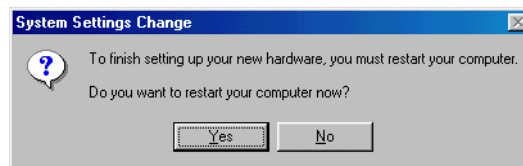

- 11 Click **Yes** to restart your computer.

When you finish setting up the USB driver, you can continue with ["Configuring TCP/IP in Windows 98 Second Edition, or Windows Me"](#) on page 20.

If you have difficulties setting up the USB driver, perform ["Removing the USB Driver from Windows 98 Second Edition or Windows Me"](#) on page 37 and repeat this procedure. If that does not correct your problem, see the *Regulatory, Safety, Software License, and Warranty Information* card provided with your SBV5121 VoIP cable modem for information about obtaining warranty service.

## Setting Up a USB Driver in Windows 2000

- 1 Insert the SBV5121 VoIP Cable Modem CD-ROM in the CD-ROM drive. This CD contains the USB drivers and must be inserted and read by the PC before you connect the VoIP cable modem to the PC.
- 2 Connect the VoIP cable modem to your computer with a USB cable. For further instructions, see “Cabling and Startup for a Single User” on page 8. A few seconds after you complete the USB connection, the Found New Hardware Wizard window is displayed:

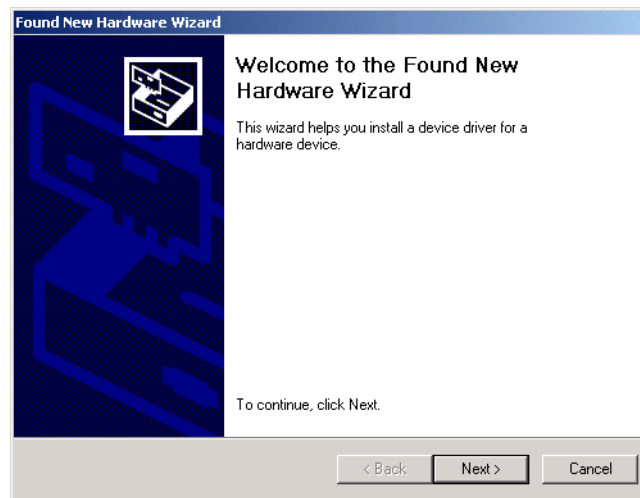

- 3 Click **Next**. The following window is displayed:



Although your VoIP cable modem model number may be different than in the images in this guide, the procedure is the same.

Be sure “Search for a suitable driver for my device” is selected.

- 4 Click **Next**. The following window is displayed:

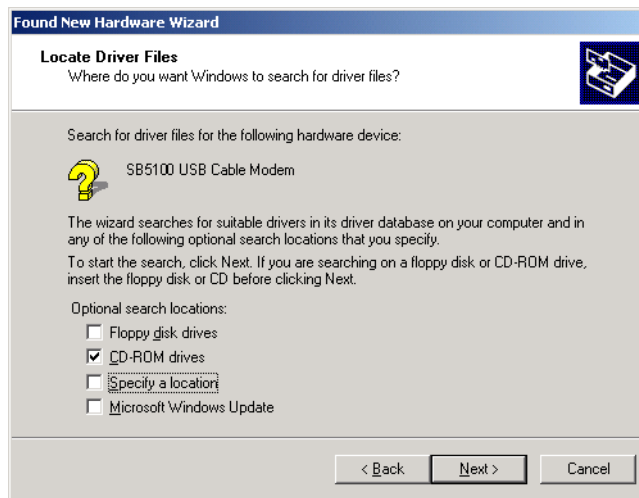

Be sure “CD-ROM drives” is the only box selected.

- 5 Click **Next**. The following window is displayed:

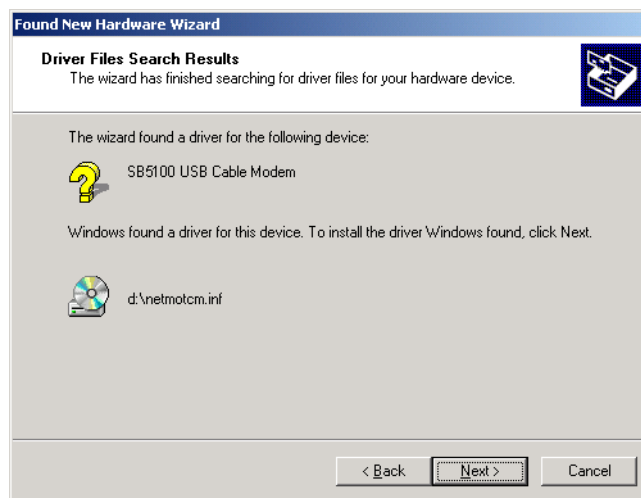

- 6 Click **Next**.

If the Insert Disk window is displayed, be sure the *SBV5121 VoIP Cable Modem* CD-ROM is in the CD-ROM drive and follow steps 7 to 11. Otherwise, if the Completing the Found New Hardware window is displayed, you can skip to step 12.

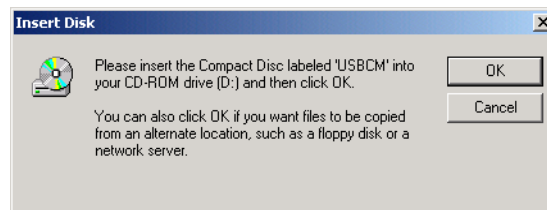



- 7 On the Insert Disk window, click **OK**. The Files Needed window is displayed:

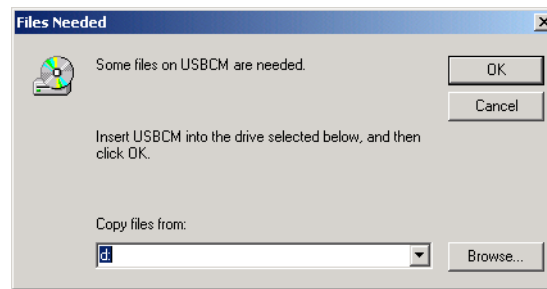

- 8 If necessary, select your CD-ROM drive in the “**Copy files from**” list.
- 9 Click **Browse**.
- 10 Double-click the **NetMotCM.sys** file in the CD-ROM root directory. The Files Needed window is displayed:
- 11 Click **OK**. The Found New Hardware Wizard window is displayed:



- 12 Click **Finish** to complete the installation.

When you finish setting up the USB driver, you can continue with [“Configuring TCP/IP in Windows 2000”](#) on page 23.

If you have any difficulties setting up the USB driver, perform [“Removing the USB Driver from Windows 2000”](#) on page 38 and repeat this procedure.

## Setting Up a USB Driver in Windows Me

- 1 Insert the *SBV5121 VoIP Cable Modem CD-ROM* in the CD-ROM drive. This CD contains the USB drivers and must be inserted and read by the PC before you connect the VoIP cable modem to the PC.
- 2 Connect the VoIP cable modem to your computer with a USB cable. For further instructions, see [“Cabling and Startup for a Single User”](#) on page 8. A few seconds after you complete the USB connection, the Add New Hardware Wizard window is displayed:



- 3 Click **Next**. Windows automatically searches for the correct USB drivers and installs them. If the installation is successful, the following window is displayed. Otherwise, be sure the *SBV5121 VoIP Cable Modem CD-ROM* is correctly inserted in your CD-ROM drive.



Although your SBV5121 VoIP cable modem model number may be different than in the images in this guide, the procedure is the same.

- 4 Click **Finish** to complete the installation.

When you finish setting up the USB driver, you can continue with [“Configuring TCP/IP in Windows 98 Second Edition, or Windows Me”](#) on page 20.

## Setting Up a USB Driver in Windows XP

- 1 Insert the *SBV5121 VoIP Cable Modem CD-ROM* in the CD-ROM drive. This CD contains the USB drivers and must be inserted and read by the PC before you connect the VoIP cable modem to the PC.
- 2 Connect the VoIP cable modem to your computer with a USB cable. For further instructions, see [“Cabling and Startup for a Single User”](#) on page 8. A few seconds after you complete the USB connection, the Found New Hardware Wizard window is displayed:



- 3 Be sure “Install the software automatically” is selected.
- 4 Click **Next**. Windows automatically searches for the correct USB drivers and installs them. the installation is successful, the following window is displayed:



Although your VoIP cable modem model number may be different than in the images in this guide, the procedure is the same.

- 5 Click **Finish** to complete the installation. Otherwise, be sure the *SBV5121 VoIP Cable Modem CD-ROM* is correctly inserted in your CD-ROM drive.

When you finish setting up the USB driver, you can continue with [“Configuring TCP/IP in Windows XP”](#) on page 26.

## Configuring TCP/IP

The SBV5121 VoIP cable modem contains all required software. You do not need to configure the VoIP cable modem, but you must be sure that your computer is configured for [TCP/IP](#) (a protocol for communication between computers). Perform *one* of the following:

- “[Configuring TCP/IP in Windows 98 Second Edition, or Windows Me](#)” on page 20
- “[Configuring TCP/IP in Windows 2000](#)” on page 23
- “[Configuring TCP/IP in Windows XP](#)” on page 26
- Follow the instructions in your Macintosh or UNIX user manual

After configuring TCP/IP, perform *one* of the following to verify the [IP address](#):

- “[Verifying the IP Address in Windows 98 Second Edition, or Windows Me](#)” on page 30
- “[Verifying the IP Address in Windows 2000 or Windows XP](#)” on page 31
- Follow the instructions in your Macintosh or UNIX user manual

Your cable provider may provide additional instructions to set up your computer.

### Configuring TCP/IP in Windows 98 Second Edition, or Windows Me

- 1 On the Windows Desktop, click **Start**.
- 2 Select **Settings** and then **Control Panel** from the pop-up menus.
- 3 Double-click the **Network** icon on the Control Panel window. The Network window is displayed:

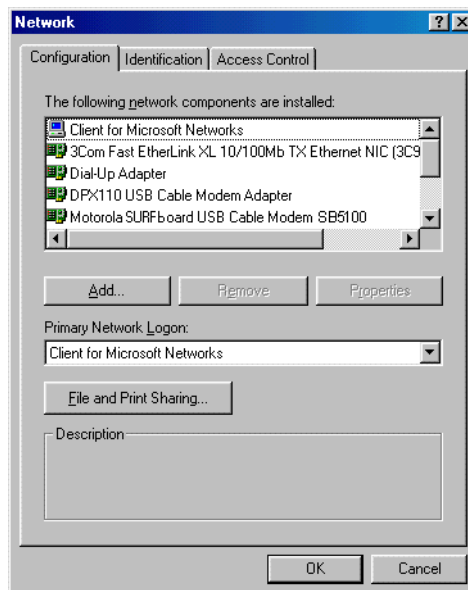

- 4 Select the **Configuration** tab.
- 5 Verify that TCP/IP is installed for the adapter that will be used to connect to the VoIP cable modem by looking for TCP/IP. If found, TCP/IP is installed. Skip to step 10. If TCP/IP is not installed for the adapter, continue with step 6.

- 6 Select the adapter to be used for the SBV5121 cable modem connection and then click **Add**. The Select Network Component Type window is displayed:

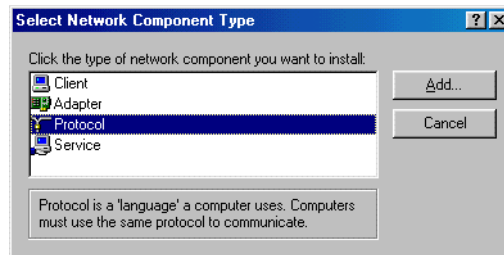

- 7 Select the **Protocol** option and click **Add**. The Select Network Protocol window is displayed:

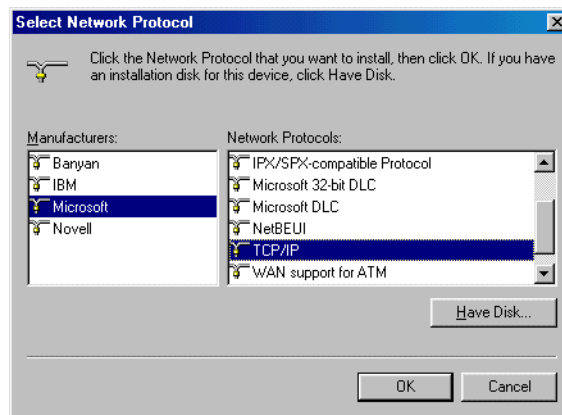

- 8 Click **Microsoft** in the Manufacturers section and click **TCP/IP** in the Network Protocol section of Select Network Protocol window.
- 9 Click **OK**.
- 10 Click **TCP/IP** on the Network window. If there is more than one TCP/IP entry, choose the one for the Ethernet card or USB port connected to the VoIP cable modem.

- 11** Click **Properties**. The TCP/IP Properties window is displayed:

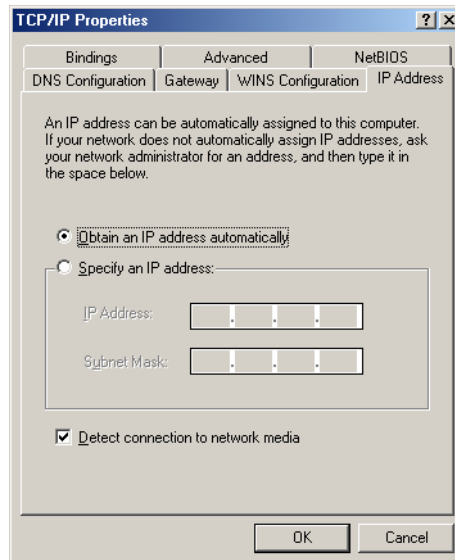

- 12** Click the **IP Address** tab.
- 13** Click **Obtain an IP address automatically**.
- 14** Click **OK** to accept the TCP/IP settings.
- 15** Click **OK** to close the Network window.
- 16** Click **OK** when prompted to restart your computer and click **OK** again.

When you complete TCP/IP configuration, go to [“Verifying the IP Address in Windows 98 Second Edition, or Windows Me”](#) on page 30.

## Configuring TCP/IP in Windows 2000

- 1 On the Windows Desktop, click **Start**.
- 2 Select **Settings** and then **Control Panel** from the pop-up menus. The Control Panel window is displayed:



In the steps that follow, a connection *number* such as 1, 2, or 3 is a reference displayed on PCs with multiple network interfaces. PCs having only one network interface may display only the label *Local Area Connection*.

- 3 Double-click the **Network and Dial-up Connections** icon on the Control Panel window. The Network and Dial-up Connections window is displayed:

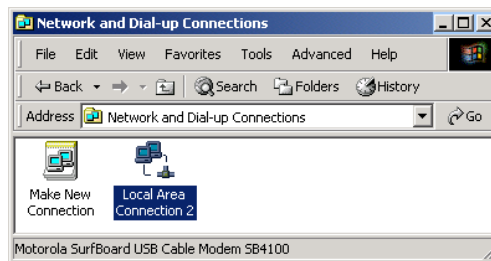

- 4 Double-click **Local Area Connection** icon. The value of *number* varies from system to system. The Local Area Connection *number* Status window is displayed:

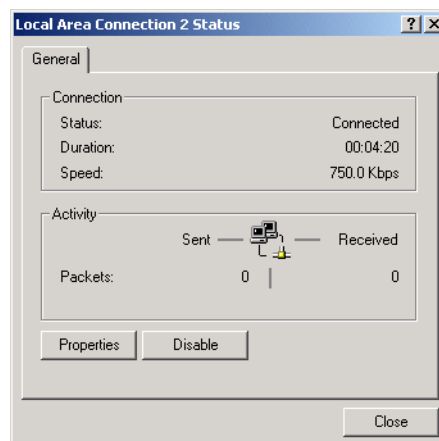

- 5 Click **Properties**. The Local Area Connection Properties window is displayed:

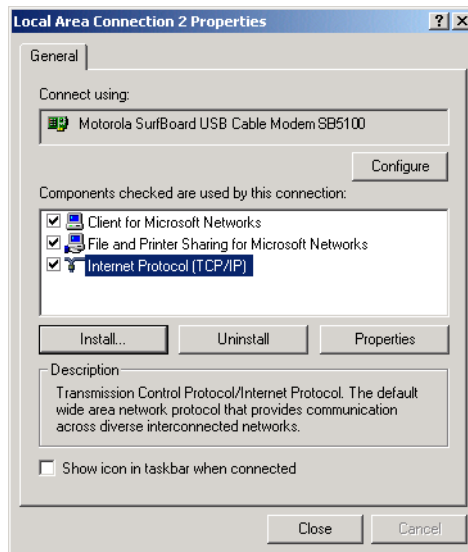

- 6 If Internet Protocol (TCP/IP) is in the list of components, TCP/IP is installed. You can skip to step 10.

If Internet Protocol (TCP/IP) is not in the list, click **Install**. The Select Network Component Type window is displayed: Continue with step 7.

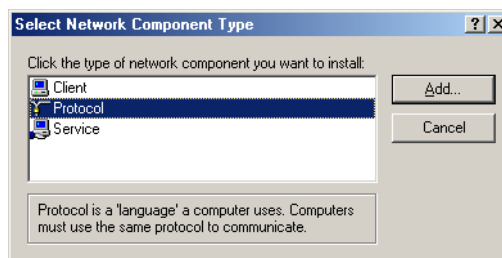

- 7 Click **Protocol** on the Select Network Component Type window and click **Add**. The Select Network Protocol window is displayed:

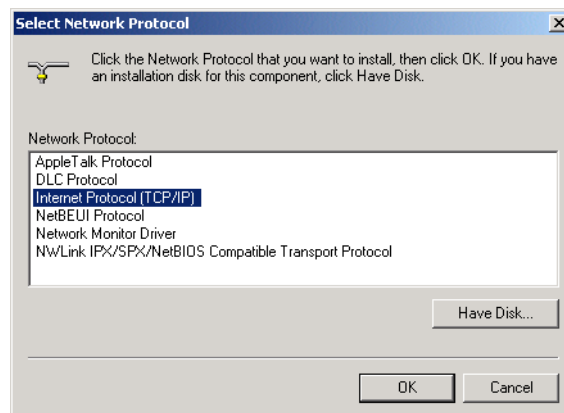

- 8 Click **Internet Protocol (TCP/IP)** in the Network Protocol section on the Select Network Protocol window.



- Click **OK**. The Local Area Connection *number* Properties window is re-displayed.

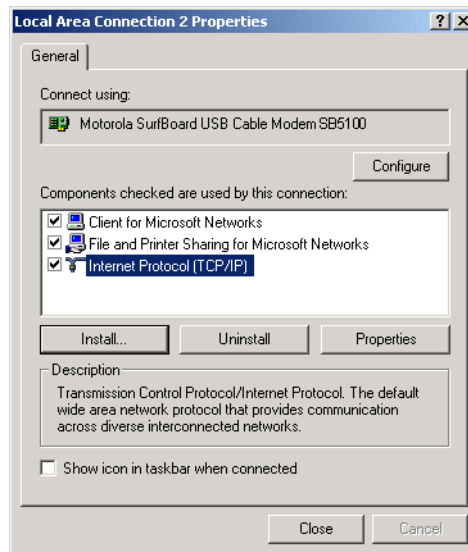

- On the Local Area Connection *number* Properties window, be sure the box next to **Internet Protocol (TCP/IP)** is selected.
- Click **Properties**. The Internet Protocol (TCP/IP) Properties window is displayed:

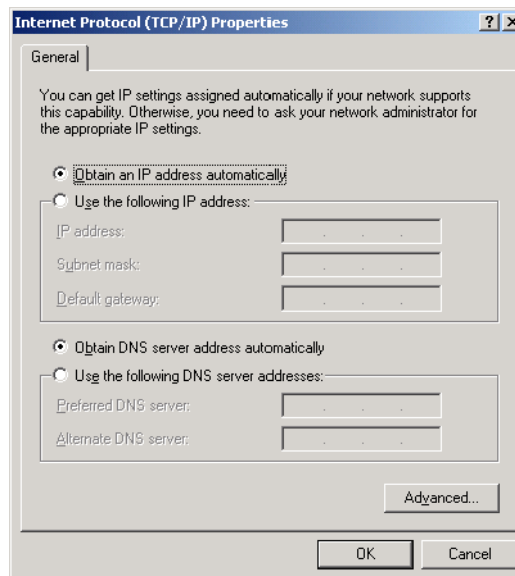

- Be sure **Obtain IP address automatically** and **Obtain DNS server address automatically** are selected. Click **OK** to accept the TCP/IP settings.
- Click **OK** to close the Local Area Connection *number* Properties window.
- Click **OK** when prompted to restart your computer and click **OK** again.

When you complete the TCP/IP configuration, go to [“Verifying the IP Address in Windows 2000 or Windows XP”](#) on page 31.

## Configuring TCP/IP in Windows XP

- 1 On the Windows desktop, click **Start** to display the Start window shown.

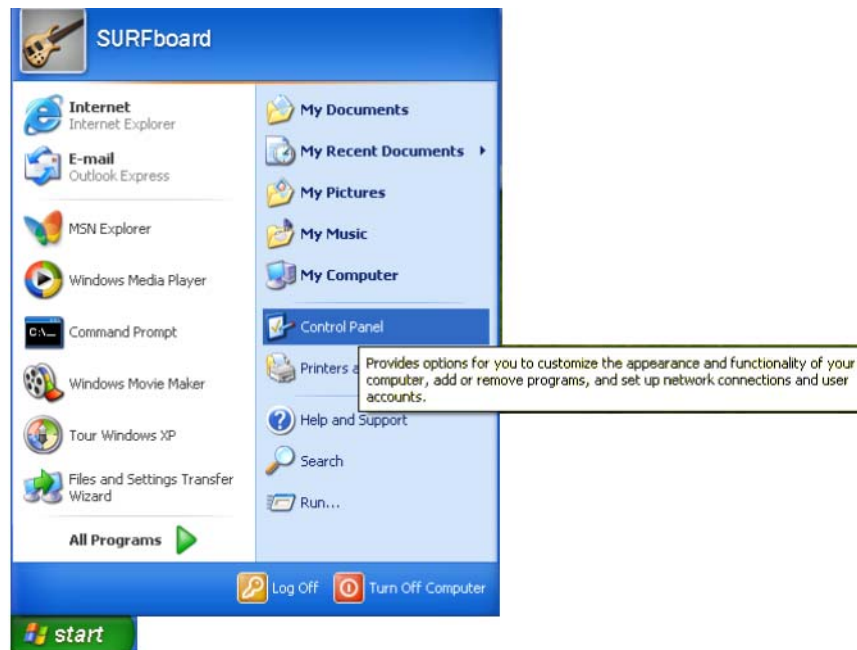

- 2 Click **Control Panel** to display the Control Panel window. The display varies, depending on your Windows XP view options. If the display is a Category view as shown below, continue with step 3. Otherwise, skip to step 5.

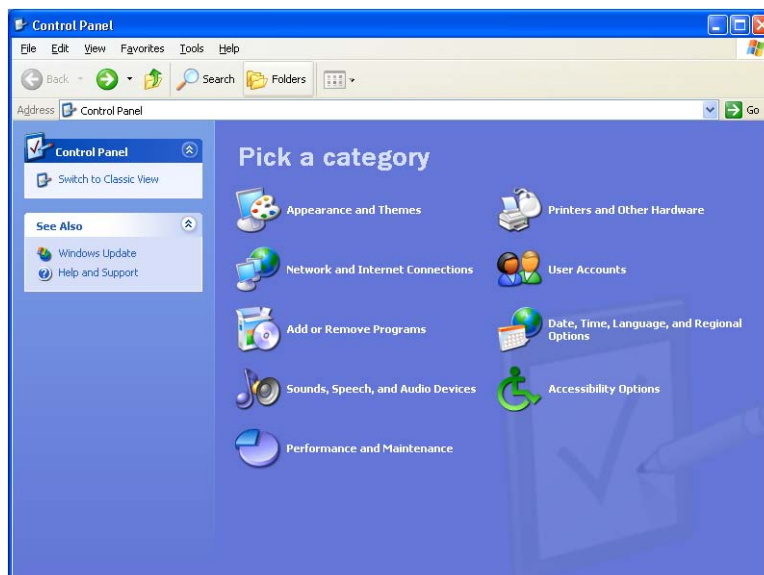

- 3 Click **Network and Internet Connections**. The Network and Internet Connections window is displayed.

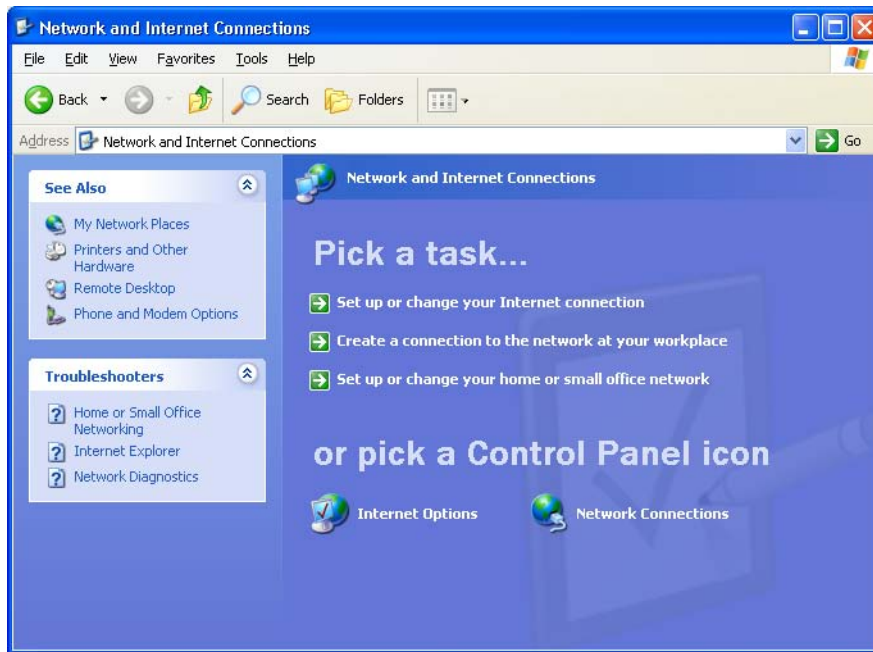

- 4 On the Network and Internet Connections window, click **Network Connections** to display the LAN or High-speed Internet connections. Skip to step 6.
- 5 If a classic view similar to below is displayed, click **Network Connections** to display the LAN or High-speed Internet connections.

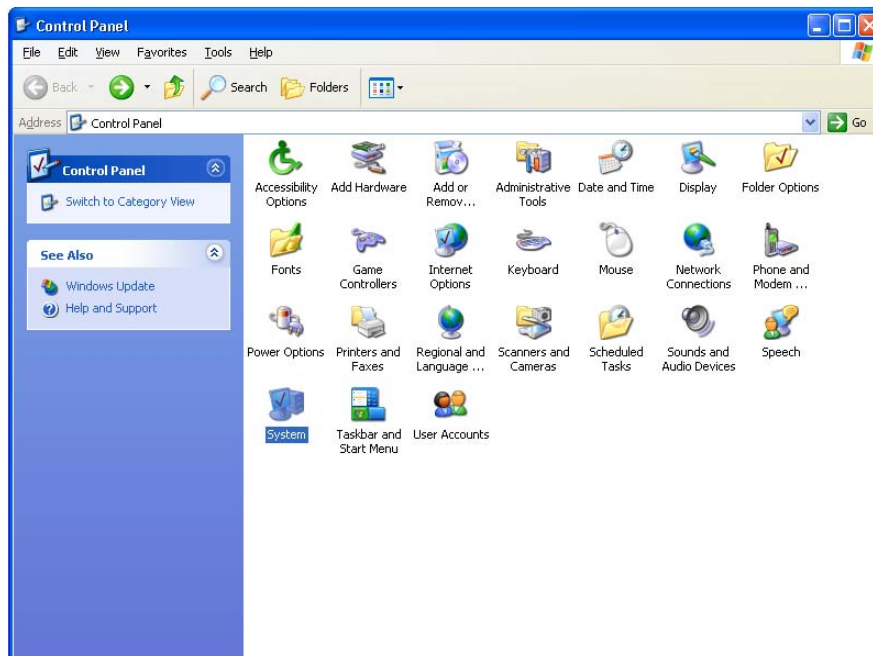

- Right-click on your network connection. If more than one connection is displayed, be sure to select the one for your network interface.

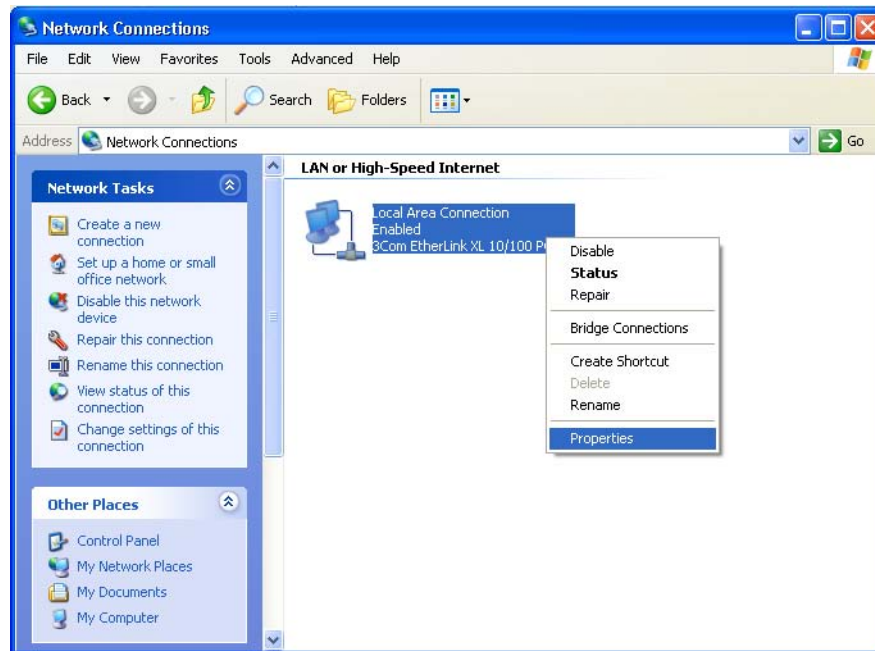

- Select **Properties** from the pop-up menu. The Local Area Connection Properties window is displayed:

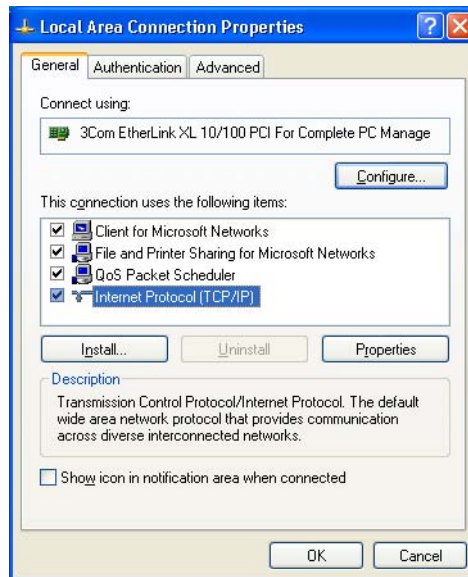

- 8 Select **Internet Protocol (TCP/IP)** and click **Properties** to display the Internet Protocol (TCP/IP) Properties window:

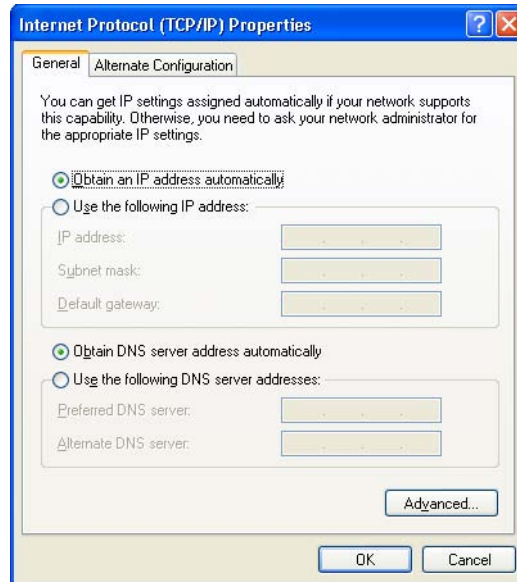

- 9 On the Internet Protocol (TCP/IP) Properties window, verify that the settings are correct, as shown.
- 10 Click **OK** to close the TCP/IP Properties window.
- 11 Click **OK** to close the Local Area Connection Properties window.

When you complete the TCP/IP configuration, go to [“Verifying the IP Address in Windows 2000 or Windows XP”](#) on page 31.

## Verifying the IP Address

The following subsections describe verifying an IP address. Perform the appropriate procedure for your Windows version:

- “Verifying the IP Address in Windows 98 Second Edition, or Windows Me” on page 30
- “Verifying the IP Address in Windows 2000 or Windows XP” on page 31

For a Macintosh or UNIX system, refer to your user guide.

### Verifying the IP Address in Windows 98 Second Edition, or Windows Me

To check the IP address:

- 1 On the Windows Desktop, click **Start**.
- 2 Select **Run**. The Run window is displayed.
- 3 Type **wiipcfg.exe** and click **OK**. A window similar to the example is displayed:

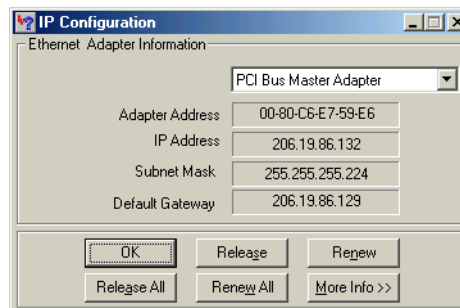

The example values for Adapter Address, IP Address, Subnet Mask, and Default Gateway on your PC will be different than in the image above.

*In Windows 98 Second Edition, if IP Autoconfiguration Address is displayed, call your service provider.*

Adapter Address	00-80-C6-E7-59-E6
IP Autoconfiguration Address	169.254.191.251

- 4 Select your adapter name — the Ethernet card or USB device.
- 5 Click **Renew**.
- 6 Click **OK** after the system displays an IP address.

If after performing this procedure your computer cannot access the Internet, call your cable provider for help.

## Verifying the IP Address in Windows 2000 or Windows XP

To check the IP address:

- 1 On the Windows Desktop, click **Start**.
- 2 Select **Run**. The Run window is displayed.
- 3 Type **cmd** and click **OK**.
- 4 Type **ipconfig** and press **ENTER** to display your IP configuration. A display, like below, indicates a normal configuration:

```

C:\WINNT\System32\cmd.exe
Microsoft Windows 2000 [Version 5.00.2195]
(C) Copyright 1985-2000 Microsoft Corp.

C:\>ipconfig

Windows 2000 IP Configuration

Ethernet adapter Local Area Connection 2:

    Connection-specific DNS Suffix  . : surfboard.com
    IP Address . . . . . : 206.19.86.174
    Subnet Mask . . . . . : 255.255.255.224
    Default Gateway . . . . . : 206.19.86.161

Ethernet adapter Local Area Connection:

    Media State . . . . . : Cable Disconnected

C:\>
    
```

If an Autoconfiguration IP Address is displayed as in the window below, there is an incorrect connection between your PC and the VoIP cable modem or there are cable network problems.

```

cmd
Microsoft Windows 2000 [Version 5.00.2195]
(C) Copyright 1985-2000 Microsoft Corp.

C:\>ipconfig

Windows 2000 IP Configuration

Ethernet adapter Local Area Connection 2:

    Connection-specific DNS Suffix  . :
    Autoconfiguration IP Address. . . : 169.254.45.20
    Subnet Mask . . . . . : 255.255.0.0
    Default Gateway . . . . . :

C:\>
    
```

Check:

- Your cable connections
- Whether you can see cable-TV channels on your television

After successfully verifying your cable connections and proper cable-TV operation, you can renew your IP address.

## Renewing Your IP Address

To renew your IP address:

- 1 On the Windows Desktop, click **Start**.
- 2 Select **Run**. The Run window is displayed.
- 3 Type **cmd** and click **OK**.
- 4 Type **ipconfig /renew** and press **ENTER**. If a valid IP address is displayed as shown, Internet access should be available.

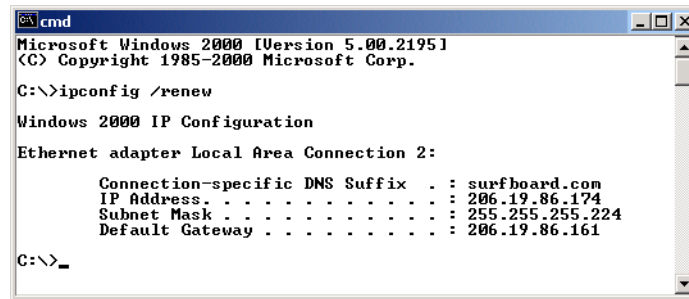

```
cmd
Microsoft Windows 2000 [Version 5.00.2195]
(C) Copyright 1985-2000 Microsoft Corp.

C:\>ipconfig /renew

Windows 2000 IP Configuration

Ethernet adapter Local Area Connection 2:

    Connection-specific DNS Suffix  . : surfboard.com
    IP Address. . . . .                : 206.19.86.174
    Subnet Mask . . . . .              : 255.255.255.224
    Default Gateway . . . . .          : 206.19.86.161

C:\>_
```

- 5 Type **exit** and press **ENTER** to return to Windows.

If after performing this procedure your computer cannot access the Internet, call your cable provider for help.



## Cabling for Multiple Users

The SBV5121 VoIP cable modem supports several multiple user configurations. Along with an optional hub or router, it can serve as an Internet gateway for up to 31 computers.

Not all service providers support multiple user service. For information about multiple user service, contact your cable provider.

### Ethernet and USB

You can connect the USB port on one computer and the Ethernet port on another computer directly to the VoIP cable modem, as shown.

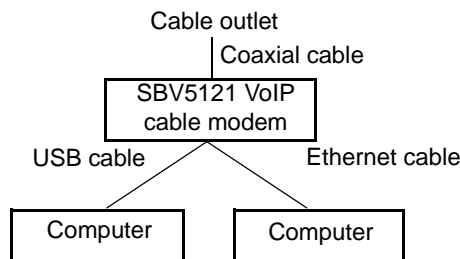

#### Caution

 Do not connect *both* the Ethernet and USB cables to the same computer.

You can connect a single computer to the USB port and from one to 31 remaining users to an Ethernet hub, as shown. You cannot connect more than one computer to the VoIP cable modem through the USB port.

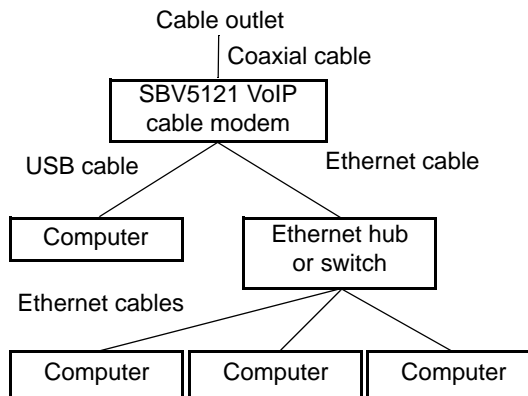

## Ethernet

You can connect up to 31 computers to an Ethernet hub connected to a SBV5121 VoIP cable modem, as shown.

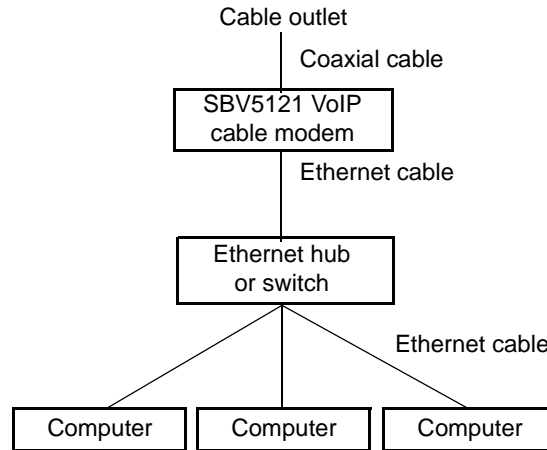

## ❖ Troubleshooting

If the solutions listed here do not solve your problem, contact your cable provider. Before calling your service provider, try pressing the reset button on the rear panel or unplugging and plugging in the VoIP cable modem power cord. Resetting the VoIP cable modem may take 5 to 30 minutes. Your service provider may ask for the status of the front-panel lights as described in [“Front-Panel Lights and Error Conditions”](#) on page 36.

<b>Problem</b>	<b>Possible Solutions</b>
<b>Green POWER light is off</b>	<ul style="list-style-type: none"> <li>• Check that the power cord is properly plugged into the electrical outlet and the VoIP cable modem.</li> <li>• Check that the electrical outlet is working.</li> <li>• If the Standby light is on, the Internet connection is off. Press the Standby button to reconnect to the Internet.</li> </ul>
<b>No telephone service</b>	<ul style="list-style-type: none"> <li>• Check the connection between the SBV5121 and your telephone.</li> <li>• If your telephone requires external power, check the AC power connection for your telephone.</li> <li>• Check the coaxial cable on the SBV5121 and the electrical outlet. Hand-tighten the cable connectors if necessary.</li> <li>• Check the lights on the front panel. Make sure the green power light is on. If it is not, check that the power cord is properly plugged into the electrical outlet and the VoIP cable modem.</li> <li>• If you have cable TV, check that your TV is working and the picture is clear. If you cannot receive your regular TV channels, your telephone service will not function.</li> </ul>
<b>Cannot send or receive data</b>	<ul style="list-style-type: none"> <li>• Check the lights on the front panel. Note the first light from top to bottom that is off. This light indicates where the error occurred, as described in <a href="#">“Front-Panel Lights and Error Conditions”</a> on page 36.</li> <li>• If all lights are off except the Standby and Tel 1/Tel 2 lights, the VoIP cable modem is in Standby mode. Press the Standby button to reconnect your Internet service. The Standby button does not affect the Tel 1/Tel 2 LEDs.</li> <li>• If you have cable TV, check that your TV is working and the picture is clear. If you cannot receive your regular TV channels, your data and telephone service will not function.</li> <li>• Check the coaxial cable on the SBV5121 and the electrical outlet. Hand-tighten the cable connectors if necessary.</li> <li>• Check the IP address. Follow the steps in <a href="#">“Verifying the IP Address in Windows 98 Second Edition, or Windows Me”</a> on page 30 or <a href="#">“Verifying the IP Address in Windows 2000 or Windows XP”</a> on page 31. Call your cable provider if you need an IP address.</li> <li>• Check that the USB or Ethernet cable is properly connected to the VoIP cable modem and your computer.</li> </ul>
<b>Problems related to unsuccessful USB driver installation</b>	<p>Remove the USB driver. Follow the instructions in <i>one</i> of:</p> <ul style="list-style-type: none"> <li>• <a href="#">“Removing the USB Driver from Windows 98 Second Edition or Windows Me”</a> on page 37</li> <li>• <a href="#">“Removing the USB Driver from Windows 2000”</a> on page 38</li> <li>• <a href="#">“Removing the USB Driver from Windows XP”</a> on page 40</li> </ul> <p>Then perform <a href="#">“Running the Motorola USB Driver Removal Utility”</a> on page 43.</p>

## Front-Panel Lights and Error Conditions

<b>Light</b>	<b>Turns Off During Startup If</b>	<b>Turns Off During Normal Operation If</b>
<b>Power</b>	The VoIP cable modem is not properly plugged into the power outlet	The VoIP cable modem is unplugged or is in standby mode. Press the Standby button
<b>DS (Receive)</b>	The receive channel cannot be acquired	The receive channel is lost
<b>US (Send)</b>	The send channel cannot be acquired	The send channel is lost
<b>Online</b>	IP registration is unsuccessful	The IP registration is lost
<b>Tel 1 or Tel 2</b>	If the Tel light fails to flash during startup, telephone line configuration has failed.	Connected during a phone call and does not blink, telephone connection is lost.

If a telephone line is properly connected and the Tel 1 or Tel 2 light remains off, the line has not been set up for service. Contact your service provider.

For more information about the lights, see [“Top and Front Panel”](#) on page 3.

## Removing the USB Driver from Windows 98 Second Edition or Windows Me

- 1 On the Windows Desktop, right-click *one* of:
  - In Windows 98 Second Edition, the **Network Neighborhood** icon
  - In Windows ME, the **My Network Places** icon

The Network window is displayed:

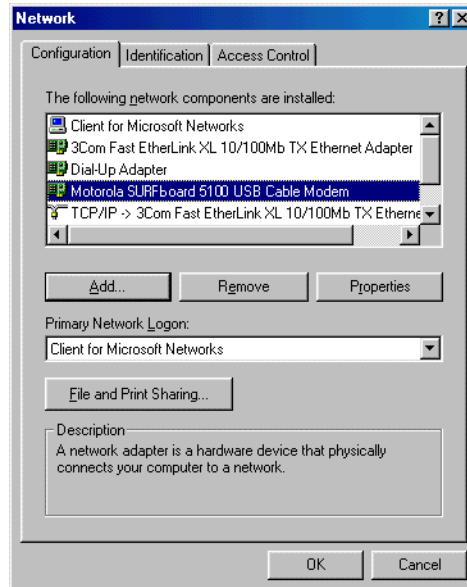

Although your VoIP cable modem model number may be different than in the images in this guide, the procedure is the same.

- 2 Click the **Motorola SURFboard USB Cable Modem** and click **Remove**. The Network window no longer displays Motorola SURFboard USB Cable Modem in the list:

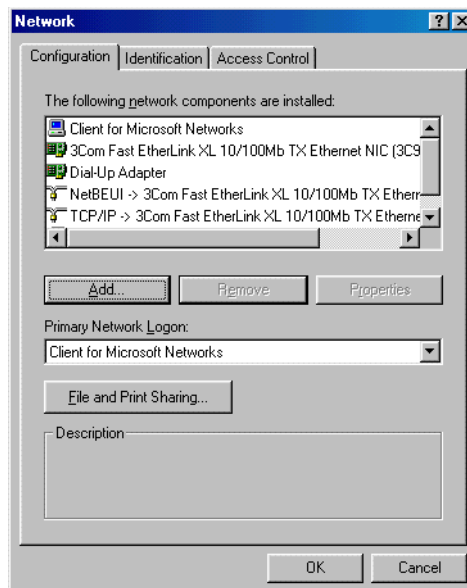

- 3 Click **OK**. The System Settings Change window is displayed:

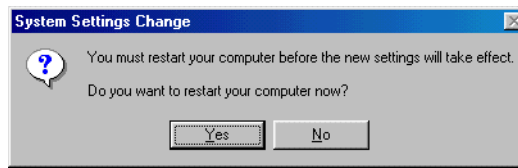

- 4 Disconnect the USB cable from your computer or VoIP cable modem.
- 5 Click **Yes** to restart your computer.
- 6 Perform “Running the Motorola USB Driver Removal Utility” on page 43.

## Removing the USB Driver from Windows 2000

- 1 On your Windows desktop, click **Start**.
- 2 Click **Settings**.
- 3 Double-click **Control Panel** to display the Control Panel window:

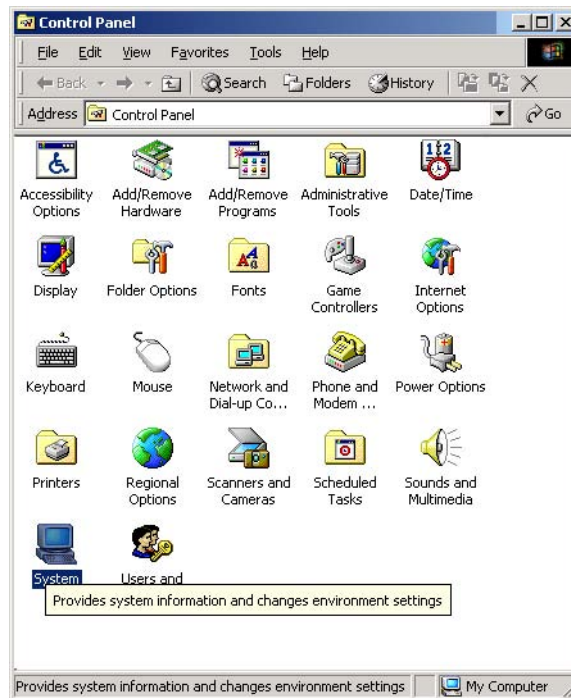

- 4 Double-click **System** to display the System Properties window.

- Click the **Hardware** tab:

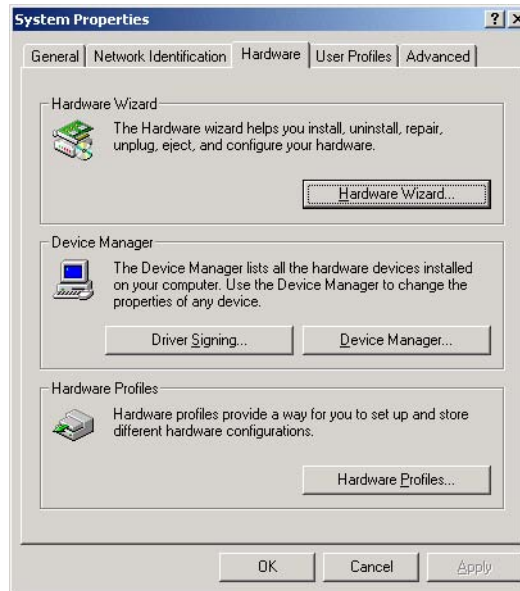

- Click **Device Manager** to display the Device Manager window:

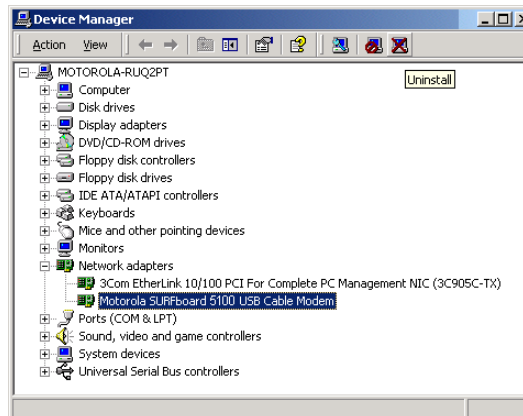

Although your VoIP cable modem model number may be different than in the images in this guide, the procedure is the same.

- Double-click **Network Adapters**.
- Click the **Motorola SURFboard USB Cable Modem**. The Uninstall icon is displayed on the window near the top.
- Click **Uninstall**. A window is displayed.
- Click **OK**.
- Close the Device Manager and Control Panel windows.
- Perform “[Running the Motorola USB Driver Removal Utility](#)” on page 43.

## Removing the USB Driver from Windows XP

- 1 On the Windows desktop, click **Start** to display the Start window shown.

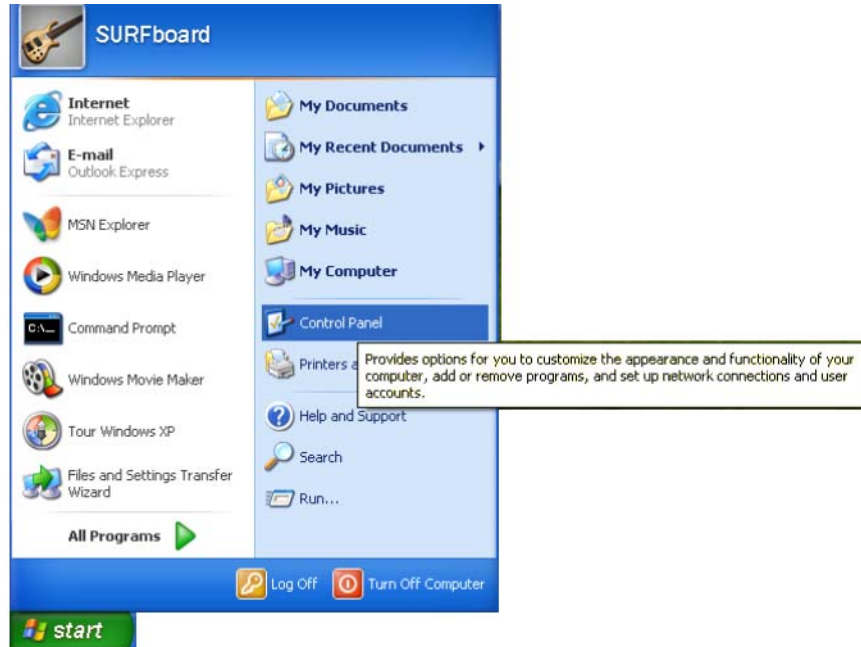

- 2 Click **Control Panel** to display the Control Panel window. The display varies, depending on your Windows XP view options.

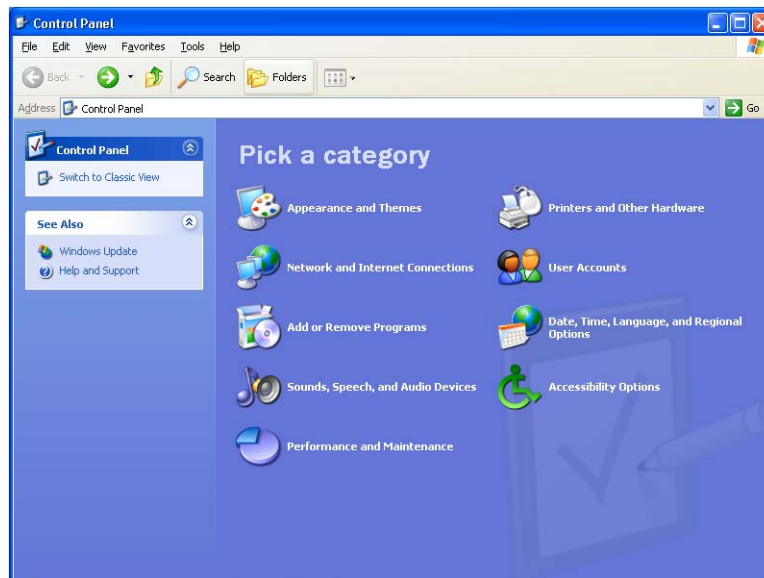



- 3 If a Category view similar to the image under step 2 is displayed, click **Performance and Maintenance**. Otherwise, skip to step 5.

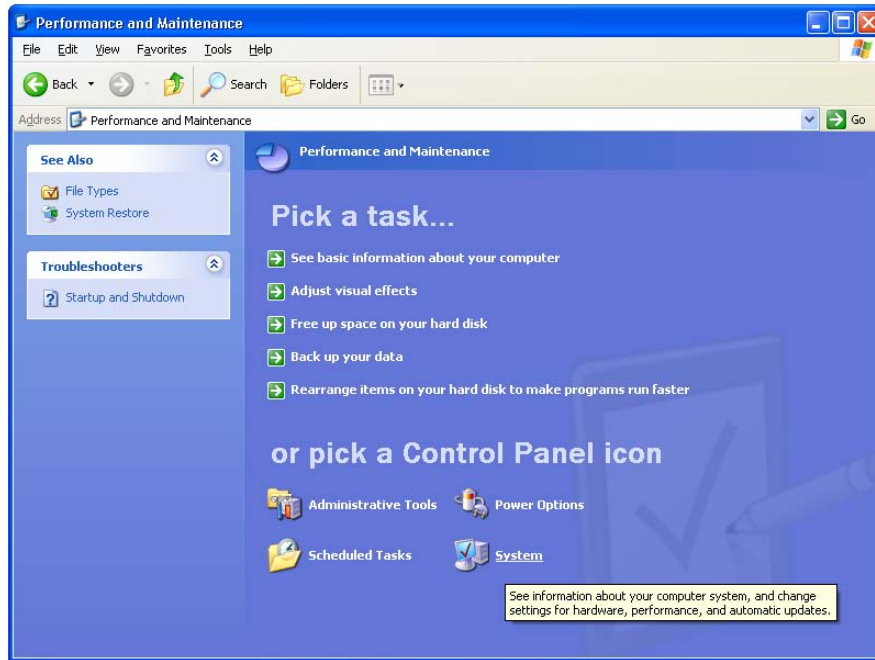

- 4 Click **System** to display the System Properties window. Skip to step 6.
- 5 If a classic view similar to the following is displayed, click **System** to display the System Properties window:

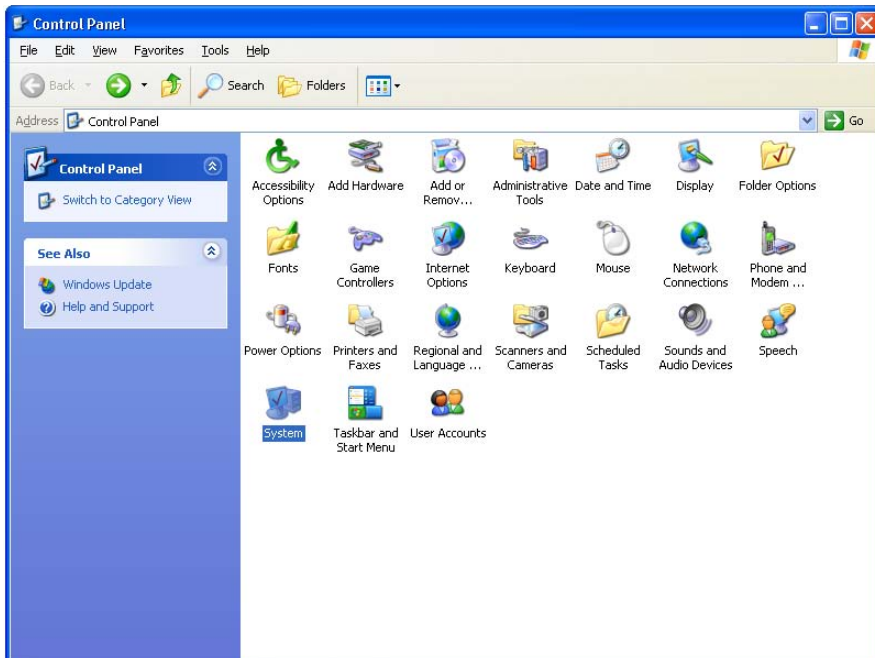

- Click the **Hardware** tab to display the Hardware page:

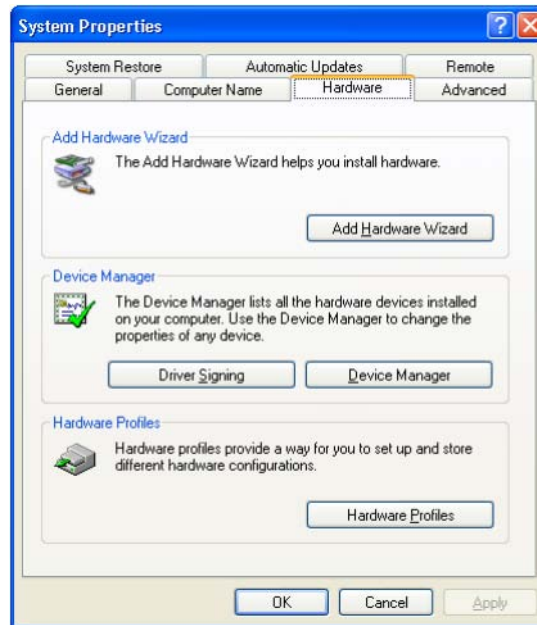

- Click **Device Manager** to display the Device Manager window:

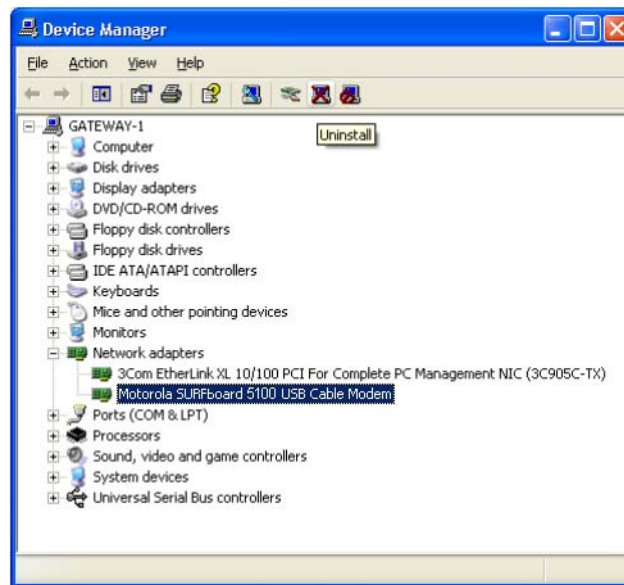

Although your VoIP cable modem model number may be different than in the images in this guide, the procedure is the same.

- Double-click **Network adapters**.
- Click the **Motorola SURFboard USB Cable Modem**. The Uninstall icon is displayed on the window near the top. Click **Uninstall**.
- Close the Device Manager window and Control Panel windows.
- Perform “[Running the Motorola USB Driver Removal Utility](#)” on page 43.

## Running the Motorola USB Driver Removal Utility

Before running the Motorola USB Driver Removal Utility, you must run the Windows Device Manager by performing *one* of:

- “Removing the USB Driver from Windows 98 Second Edition or Windows Me” on page 37
- “Removing the USB Driver from Windows 2000” on page 38
- “Removing the USB Driver from Windows XP” on page 40

To run the Motorola USB Driver Removal Utility:

- 1 Insert the *SBV5121 VoIP Cable Modem* CD-ROM in the CD-ROM drive. After a short time, a window with language choices is displayed.
- 2 Press the **Esc** key on the keyboard to exit the start-up screens.
- 3 To start Windows Explorer, click **Start** and select **Run**. On the Run window, type **explorer** and click **OK**.

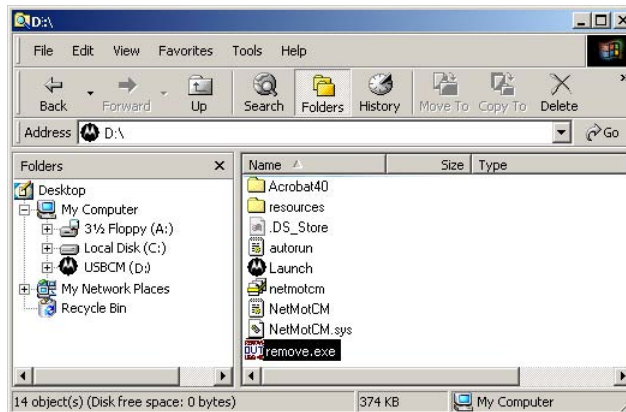

Your Windows Explorer may appear different than in the image on this page. There are variations between Windows versions and you can configure Windows Explorer as you like.

- 4 Double-click **My Computer**.
- 5 Double-click the **Motorola** CD icon (D: in the image).
- 6 Double-click **remove** or **remove.exe** to run the Remove utility from the *SBV5121 VoIP Cable Modem* CD-ROM. The Motorola USB Driver Removal window is displayed. *Be sure the USB cable is disconnected.*



7 Click **Remove Driver**. A progress bar indicates that the driver is being removed.



The following window displays when the USB driver has been successfully removed:



8 Click **Exit** to exit the Motorola USB Driver Removal Utility.

or

You can click **Details** to display informational messages about the files that were found and deleted, similar to the ones shown. If necessary, scroll down to view the entire list. Click **OK** to close the details window:

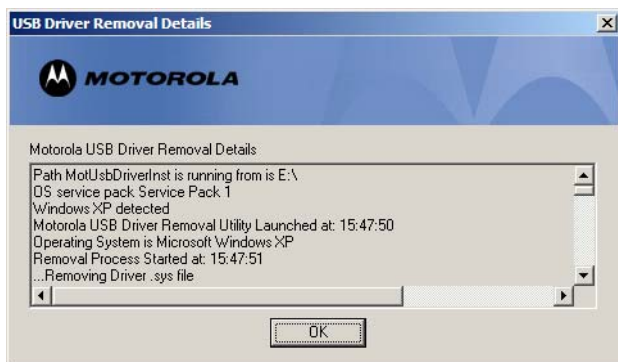

Re-install the USB driver following *one* of:

- "Setting Up a USB Driver in Windows 98 Second Edition" on page 11
- "Setting Up a USB Driver in Windows 2000" on page 15
- "Setting Up a USB Driver in Windows Me" on page 18
- "Setting Up a USB Driver in Windows XP" on page 19

If you continue to have problems, contact your cable provider.

## Contact Us

If you need assistance while working with the VoIP cable modem, contact your cable provider. For more information about customer service, technical support, or warranty claims, see the *Regulatory, Safety, Software License, and Warranty Information* card provided with the VoIP cable modem.

For answers to typical questions, see “[Frequently Asked Questions](#)” on page 45.

For information about Motorola consumer cable products, education, and support, visit [www.motorola.com/broadband/consumers](http://www.motorola.com/broadband/consumers).

## Frequently Asked Questions

Here are answers to questions our customers frequently ask.

**Q What is high-speed cable Internet access?**

**A** Cable Internet access uses cable television wires instead of telephone lines to connect to the Internet. It is extremely fast and affordable and does not tie up telephone lines for incoming or outgoing calls and faxes.

**Q What is voice over Internet Protocol (VoIP)?**

**A** VoIP uses cable television wires instead of traditional telephone lines to provide voice and fax service.

**Q How fast is a VoIP cable modem?**

**A** A cable modem offers Internet access at speeds up to 100 times faster than a traditional phone modem. You can experience speeds of over 1,000 Kbps. Network conditions such as traffic volume and the speed of the sites you visit can affect download speeds.

**Q Can I still watch cable TV while using my VoIP cable modem?**

**A** Yes, your cable TV line can carry the TV signal while you send and receive information on the Internet.

**Q What are CableLabs® Certified, DOCSIS® and Euro-DOCSIS?**

**A** CableLabs Certified, DOCSIS, and Euro-DOCSIS are the industry standards for high-speed data distribution over cable television system networks. They are intended to ensure that all compliant VoIP cable modems interface with all compliant cable systems. Your Motorola SBV5121 VoIP cable modem is DOCSIS or Euro-DOCSIS certified.

**Q What is PacketCable?**

**A** PacketCable™ is an evolving set of interface specifications for delivering advanced, real-time multimedia services over cable; for example, VoIP, multimedia conferencing, and interactive gaming.

**Q If I have a VoIP cable modem, can I still use my old 28.8 Kbps or 56 Kbps modem?**

**A** Yes! Although once you've experienced the speed of cable Internet access, you'll never again want to wait for traditional dial-up services.

**Q I have more than one computer. Do I need more than one VoIP cable modem?**

**A** No, not if your computers are connected on a network. The VoIP cable modem supports current Internet connection sharing technologies to enable you to connect up to 31 computers to the Internet using a single VoIP cable modem.

**Q Do I need to change my Internet service provider (ISP)?**

**A** Currently, most Internet service providers do not provide cable Internet access. Contact your cable company for your specific information.

**Q Do I need to subscribe to cable TV to get cable Internet access?**

**A** No, but you will need to subscribe to cable Internet service. Some systems require that you subscribe to basic service before you can get Internet access and/or offer a discount when you use your own VoIP cable modem. Check with your local cable company for specific information.

**Q What type of technical support is available?**

**A** For questions about your Internet service, connection, or VoIP cable modem, contact your cable provider.

**Q What do I do if my VoIP cable modem stops working?**

**A** “[Troubleshooting](#)” on page 35 provides tips to diagnose problems and simple solutions. If you continue to have problems, contact your cable provider or Motorola as described in “[Contact Us](#)” on page 45.

## Glossary

<b>coaxial cable (coax)</b>	A type of wire consisting of a center wire surrounded by insulation and a grounded shield of braided wire. The shield minimizes electrical and radio frequency interference.
<b>DOCSIS</b>	The CableLabs Data-Over-Cable Service Interface Specification defines interface standards for VoIP cable modems and supporting equipment.
<b>download</b>	To copy a file from one computer to another. You can use the Internet to download files from a server to your home PC. A DOCSIS VoIP cable modem downloads its configuration from a server during start-up.
<b>downstream</b>	In a network, downstream describes the direction of data received by your computer from the Internet.
<b>Ethernet</b>	The most widely used type of local area network (LAN). The most commonly installed Ethernet networks are called 10Base-T. 10Base-T provides transmission speeds up to 10 megabits per second (Mbps), usually over twisted-pair wire. Fast Ethernet (100Base-T) provides transmission speeds up to 100 Mbps.
<b>expansion slot</b>	An opening in a computer where a circuit board can be inserted to add new capabilities.
<b>F-type connector</b>	A connector used to connect coaxial cable to equipment.
<b>IP address</b>	An Internet Protocol address is an identifier for a computer or device on a TCP/IP network. Networks using the TCP/IP protocol route messages based on the destination IP address. Your cable provider assigns your VoIP cable modem an IP address to provide a continuous Internet connection.
<b>MAC address</b>	The Media Access Control Address uniquely identifies each device that can be connected to an Ethernet network. It is permanently written to read-only memory (ROM) at the factory and printed on the rear panel of your VoIP cable modem. You need to provide the MAC address to your cable provider.
<b>MHz</b>	Mega Hertz. A measure of radio frequency - millions of cycles per second. One MHz means one million cycles per second.
<b>PBX</b>	A private branch exchange is a private telephone network usually used within a business. Users of the PBX share a certain number of outside lines for making telephone calls external to the PBX.
<b>PSTN</b>	The public switched telephone network is the traditional circuit-switched, voice-oriented telephone network originally invented by Alexander Graham Bell. It is sometimes referred to as plain old telephone service (POTS).
<b>RJ-11</b>	The most common type of connector for household phones.
<b>RJ-45</b>	The most common type of connector for Ethernet networks.
<b>splitter</b>	A splitter is a device that divides the signal power from an input cable equally between two or more signals, each carrying a selected frequency range.
<b>TCP/IP</b>	Transmission Control Protocol/Internet Protocol is a set of protocols that provides standards and rules for communication between networks.
<b>upstream</b>	In a network, upstream describes the direction of data sent from your computer to the Internet.
<b>UPS</b>	An uninterruptible power supply provides a battery backup to enable voice service to continue for some time during a power outage.

<b>USB</b>	Universal Serial Bus is a computer interface for add-on devices such as printers, scanners, and VoIP cable modems. When you connect your VoIP cable modem to the USB port, Windows 98 Second Edition and later versions automatically recognize the VoIP cable modem.
<b>VoIP</b>	Voice over Internet Protocol is a method to exchange voice, fax, and other information over the Internet. Voice and fax have traditionally been carried over traditional telephone lines using a dedicated circuit for each line. VoIP enables calls to travel as discrete data packets on shared lines.



## Software License

SBV5121 VoIP Cable Modem  
Motorola, Inc., Connected Home Solutions Business ("Motorola")  
101 Tournament Drive  
Horsham, PA 19044

**IMPORTANT: PLEASE READ THIS SOFTWARE LICENSE ("LICENSE") CAREFULLY BEFORE YOU INSTALL, DOWNLOAD OR USE ANY APPLICATION SOFTWARE, USB DRIVER SOFTWARE, FIRMWARE AND RELATED DOCUMENTATION ("SOFTWARE") PROVIDED WITH MOTOROLA'S CABLE DATA PRODUCT (THE "CABLE DATA PRODUCT"). BY USING THE CABLE DATA PRODUCT AND/OR INSTALLING, DOWNLOADING OR USING ANY OF THE SOFTWARE, YOU INDICATE YOUR ACCEPTANCE OF EACH OF THE TERMS OF THIS LICENSE. UPON ACCEPTANCE, THIS LICENSE WILL BE A LEGALLY BINDING AGREEMENT BETWEEN YOU AND MOTOROLA. THE TERMS OF THIS LICENSE APPLY TO YOU AND TO ANY SUBSEQUENT USER OF THIS SOFTWARE.**

**IF YOU DO NOT AGREE TO ALL OF THE TERMS OF THIS LICENSE (I) DO NOT INSTALL OR USE THE SOFTWARE AND (II) RETURN THE CABLE DATA PRODUCT AND THE SOFTWARE (COLLECTIVELY, "PRODUCT"), INCLUDING ALL COMPONENTS, DOCUMENTATION AND ANY OTHER MATERIALS PROVIDED WITH THE PRODUCT, TO YOUR POINT OF PURCHASE OR SERVICE PROVIDER, AS THE CASE MAY BE, FOR A FULL REFUND. BY INSTALLING OR USING THE SOFTWARE, YOU AGREE TO BE BOUND BY THE PROVISIONS OF THIS LICENSE AGREEMENT.**

The Software includes associated media, any printed materials, and any "on-line" or electronic documentation. Software provided by third parties may be subject to separate end-user license agreements from the manufacturers of such Software.

The Software is never sold. Motorola licenses the Software to the original customer and to any subsequent licensee for personal use only on the terms of this License. Motorola and its 3<sup>rd</sup> party licensors retain the ownership of the Software.

**You may:**

USE the Software only in connection with the operation of the Product.

TRANSFER the Software (including all component parts and printed materials) permanently to another person, but only if the person agrees to accept all of the terms of this License. If you transfer the Software, you must at the same time transfer the Product and all copies of the Software (if applicable) to the same person or destroy any copies not transferred.

TERMINATE this License by destroying the original and all copies of the Software (if applicable) in whatever form.

**You may not:**

(1) Loan, distribute, rent, lease, give, sublicense or otherwise transfer the Software, in whole or in part, to any other person, except as permitted under the TRANSFER paragraph above. (2) Copy or translate the User Guide included with the Software, other than for personal use. (3) Copy, alter, translate, decompile, disassemble or reverse engineer the Software, including but not limited to, modifying the Software to make it operate on non-compatible hardware. (4) Remove, alter or cause not to be displayed, any copyright notices or startup message contained in the Software programs or documentation. (5) Export the Software or the Product components in violation of any United States export laws.

The Product is not designed or intended for use in on-line control of aircraft, air traffic, aircraft navigation or aircraft communications; or in design, construction, operation or maintenance of any nuclear facility. MOTOROLA AND ITS 3<sup>RD</sup> PARTY LICENSORS DISCLAIM ANY EXPRESS OR IMPLIED WARRANTY OF FITNESS FOR SUCH USES. YOU REPRESENT AND WARRANT THAT YOU SHALL NOT USE THE PRODUCT FOR SUCH PURPOSES.

Title to this Software, including the ownership of all copyrights, mask work rights, patents, trademarks and all other intellectual property rights subsisting in the foregoing, and all adaptations to and modifications of the foregoing shall at all times remain with Motorola and its 3<sup>rd</sup> party licensors. Motorola retains all rights not expressly licensed under this License. The Software, including any images, graphics, photographs, animation, video, audio, music and text incorporated therein is owned by Motorola or its 3<sup>rd</sup> party licensors and is protected by United States copyright laws and international treaty provisions. Except as otherwise expressly provided in this License, the copying, reproduction, distribution or preparation of derivative works of the Software, any portion of the Product or the documentation is strictly prohibited by such laws and treaty provisions. Nothing in this License constitutes a waiver of Motorola's rights under United States copyright law.

This License and your rights regarding any matter it addresses are governed by the laws of the Commonwealth of Pennsylvania, without reference to conflict of laws principles. THIS LICENSE SHALL TERMINATE AUTOMATICALLY if you fail to comply with the terms of this License.

Motorola is not responsible for any third party software provided as a bundled application, or otherwise, with the Software.

**U.S. GOVERNMENT RESTRICTED RIGHTS**

The Product and documentation is provided with RESTRICTED RIGHTS. The use, duplication or disclosure by the Government is subject to restrictions as set forth in subdivision (c)(1)(ii) of The Rights in Technical Data and Computer Software clause at 52.227-7013. The contractor/manufacturer is Motorola, Inc., Connected Home Solutions Business, 101 Tournament Drive, Horsham, PA 19044.

Visit our website at:  
[www.motorola.com](http://www.motorola.com)



527693-001  
3/06