

DrayTek

VigorFly 210

WiFi Router



Quick Start Guide

V1.0

VigorFly 210 Series

Quick Start Guide

Version: 1.1

Date: July 09, 2014

Warranty

We warrant to the original end user (purchaser) that the router will be free from any defects in workmanship or materials for a period of two (2) year from the date of purchase from the dealer. Please keep your purchase receipt in a safe place as it serves as proof of date of purchase. During the warranty period, and upon proof of purchase, should the product have indications of failure due to faulty workmanship and/or materials, we will, at our discretion, repair or replace the defective products or components, without charge for either parts or labor, to whatever extent we deem necessary to restore the product to proper operating condition. Any replacement will consist of a new or re-manufactured functionally equivalent product of equal value, and will be offered solely at our discretion. This warranty will not apply if the product is modified, misused, tampered with, damaged by an act of God, or subjected to abnormal working conditions. The warranty does not cover the bundled or licensed software of other vendors. Defects which do not significantly affect the usability of the product will not be covered by the warranty. We reserve the right to revise the manual and online documentation and to make changes from time to time in the contents hereof without obligation to notify any person of such revision or changes.

European Community Declarations

Manufacturer: DrayTek Corp.
Address: No. 26, Fu Shing Road, HuKou Township, HsinChu Industrial Park, Hsin-Chu, Taiwan 303
Product: VigorFly 210

DrayTek Corp. declares that VigorFly 210 is in compliance with the following essential requirements and other relevant provisions of R&TTE Directive 1999/5/EC.

The product conforms to the requirements of Electro-Magnetic Compatibility (EMC) Directive 2004/108/EC by complying with the requirements set forth in EN55022/Class B and EN55024/Class B.

The product conforms to the requirements of Low Voltage (LVD) Directive 2006/95/EC by complying with the requirements set forth in EN60950-1.

Federal Communication Commission Interference Statement

This equipment has been tested and found to comply with the limits for a Class B digital device, pursuant to Part 15 of the FCC Rules. These limits are designed to provide reasonable protection against harmful interference in a residential installation. This equipment generates, uses and can radiate radio frequency energy and, if not installed and used in accordance with the instructions, may cause harmful interference to radio communications. However, there is no guarantee that interference will not occur in a particular installation. If this equipment does cause harmful interference to radio or television reception, which can be determined by turning the equipment off and on, the user is encouraged to try to correct the interference by one of the following measures:

- Reorient or relocate the receiving antenna.
- Increase the separation between the equipment and receiver.
- Connect the equipment into an outlet on a circuit different from that to which the receiver is connected.
- Consult the dealer or an experienced radio/TV technician for help.

This device complies with Part 15 of the FCC Rules. Operation is subject to the following two conditions:

- (1) This device may not cause harmful interference, and
- (2) This device may accept any interference received, including interference that may cause undesired operation.

This product is designed for 2.4GHz WLAN network throughout the EC region and Switzerland with restrictions in France. **The antenna/transmitter should be kept at least 20 cm away from human body.**



You are cautioned that changes or modifications not expressly approved by the party responsible for compliance could void your authority to operate the equipment.

FCC RF Radiation Exposure Statement

1. This Transmitter must not be co-located or operating in conjunction with any other antenna or transmitter.
2. This equipment complies with FCC RF radiation exposure limits set forth for an uncontrolled environment. This equipment should be installed and operated with a minimum distance of 20 centimeters between the radiator and your body.

1

Package Content

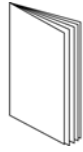

Quick Start Guide

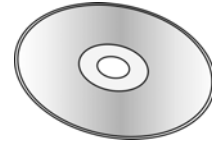

CD

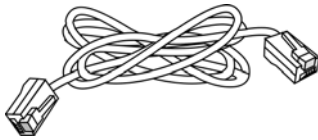

RJ-45 Cable (Ethernet)

The type of the power adapter depends on the country that the router will be installed:

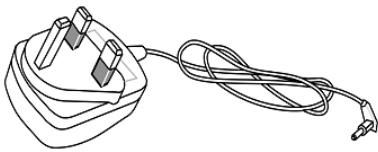

UK-type power adapter

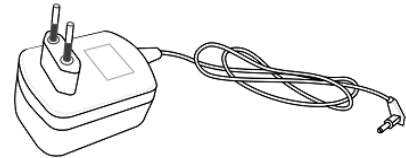

EU-type power adapter

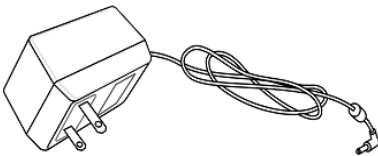

USA/Taiwan-type power adapter

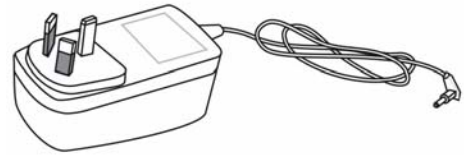

AU/NZ-type Power Adapter

2

Descriptions of Components

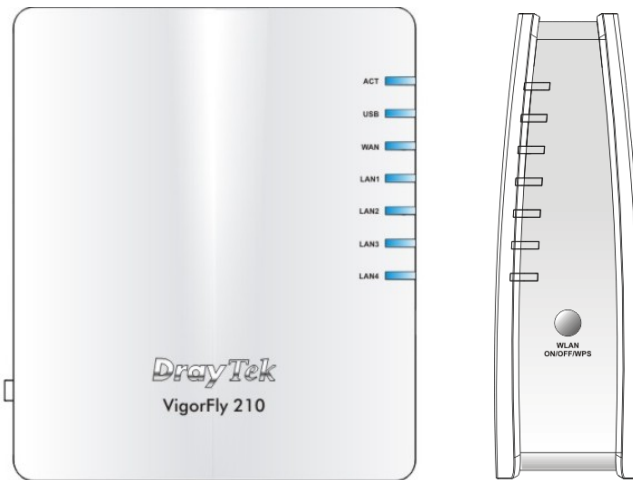

LED	Status	Explanation
ACT	Off	The system is not ready or is failed.
	Blinking	The system is ready and can work normally.
USB	On	A USB device is connected and active.
	Blinking	The data is transmitting.
WAN	On	The WAN port is connected.
	Blinking	It will blink while transmitting data.
LAN 1 - 4	On	A normal connection is through its corresponding port.
	Off	LAN is disconnected.
	Blinking	Data is transmitting (sending/receiving).
WLAN (Blue LED) on WLAN button	On	Wireless access point is ready.
	Off	Wireless access point is not ready.
	Blinking (Blue)	Blink when wireless traffic goes through.
WPS (Orange LED) on WLAN button	Off	The WPS is off.
	Blinking (Orange)	Blink with 1 second cycle for 2 minutes - - WPS is enabled and waiting for wireless client to connect with it.
	Blinking (Orange)	Blink when wireless traffic goes through.
WPS Button	Press this button for 2 seconds to wait for client device making network connection through WPS. When the orange LED lights up, the WPS will be on.	

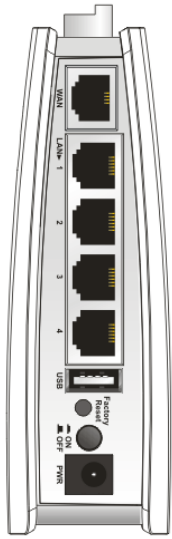

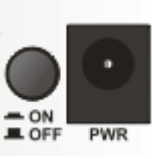
Interface	Description
WAN	Connector for accessing the Internet.
LAN 1 - 4	Connector for local network devices.
USB	Connector for a printer or 3G backup.
	Restore the default settings. Usage: Turn on the router. Press the button and keep for more than 10 seconds. Then the router will restart with the factory default configuration.
	ON/OFF: Power switch. PWR: Connector for a power adapter.

3

Installing Your Router

This section will guide you to install the router through hardware connection and configure the router's settings through web browser.

Before starting to configure the router, you have to connect your devices correctly.

1. Connect this device to a modem with an Ethernet cable.
2. Connect the LAN port to your computer with a RJ-45 cable.
3. Connect one end of the power adapter to the Power port of this device. Connect the other end to the wall outlet of electricity.
4. Power on the router.
5. Check the **ACT**, **WAN** and **LAN** LEDs to assure network connections.



4

Configuring Web Pages

The **Quick Start Wizard** is designed for you to easily set up your router for Internet access.

1. Make sure your PC connects to the router correctly.
2. Open a web browser on your PC and type **http://192.168.1.1**. A pop-up window will open to ask for username and password. Please type “admin/admin” on Username/Password and click **Login** for configuration.

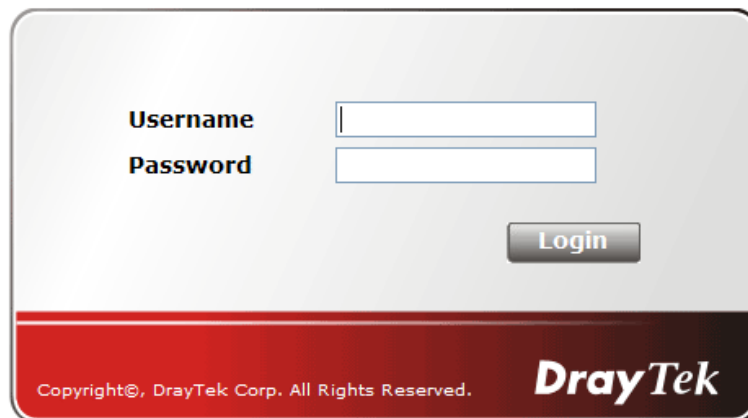

A login form with two input fields: "Username" and "Password". Below the fields is a "Login" button. At the bottom, there is a red banner with the text "Copyright©, DrayTek Corp. All Rights Reserved." and the "DrayTek" logo.



Note: If you fail to access to the web configuration, please go to “Trouble Shooting” for detecting and solving your problem in User’s Guide.

3. Now, the **Main Screen** will pop up. Click **Quick Start Wizard**.

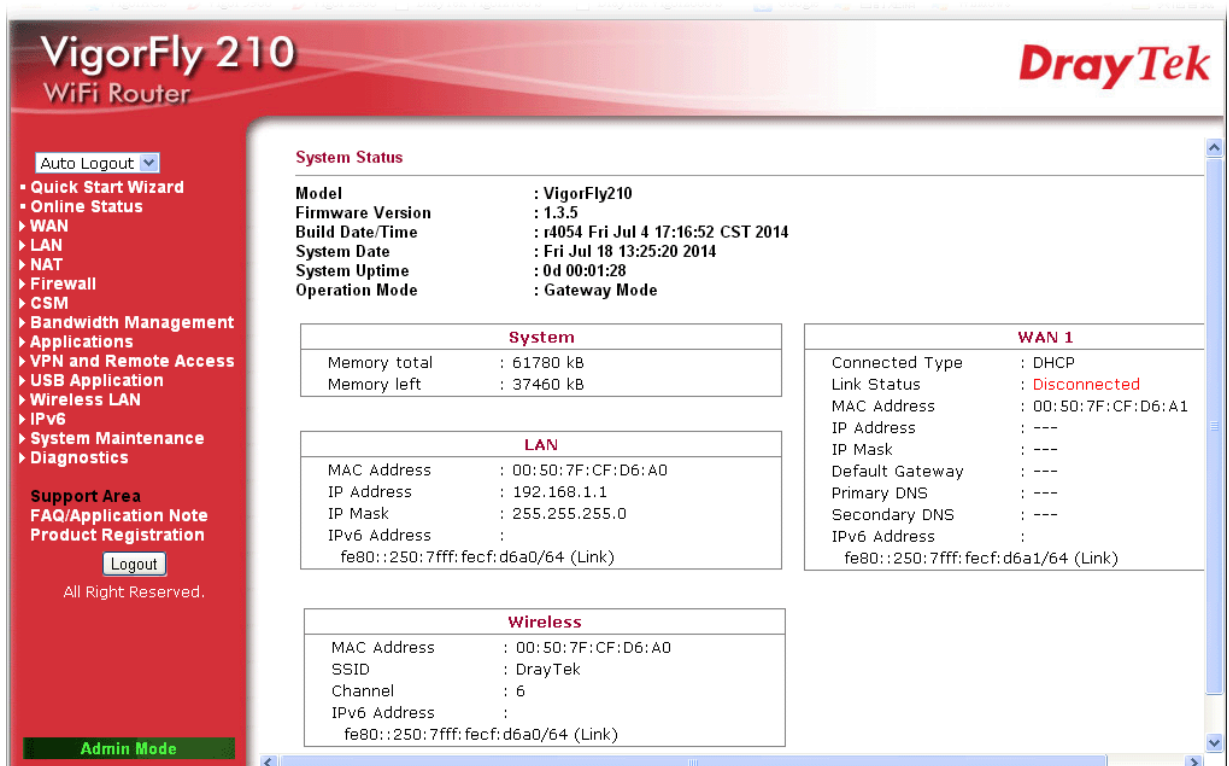

The main screen of the VigorFly 210 WiFi Router. The interface is divided into a left sidebar and a main content area. The sidebar contains a navigation menu with items like "Quick Start Wizard", "Online Status", "WAN", "LAN", "NAT", "Firewall", "Bandwidth Management", "Applications", "VPN and Remote Access", "USB Application", "Wireless LAN", "IPv6", "System Maintenance", and "Diagnostics". Below the menu is a "Support Area" with "FAQ/Application Note" and "Product Registration", and a "Logout" button. The main content area displays "System Status" information, including Model (VigorFly210), Firmware Version (1.3.5), Build Date/Time (r4054 Fri Jul 4 17:16:52 CST 2014), System Date (Fri Jul 18 13:25:20 2014), System Uptime (0d 00:01:28), and Operation Mode (Gateway Mode). Below this are three tables: "System", "LAN", and "Wireless", each showing various status metrics and IP addresses.

System Status	
Model	: VigorFly210
Firmware Version	: 1.3.5
Build Date/Time	: r4054 Fri Jul 4 17:16:52 CST 2014
System Date	: Fri Jul 18 13:25:20 2014
System Uptime	: 0d 00:01:28
Operation Mode	: Gateway Mode

System	
Memory total	: 61780 kB
Memory left	: 37460 kB

LAN	
MAC Address	: 00:50:7F:CF:D6:A0
IP Address	: 192.168.1.1
IP Mask	: 255.255.255.0
IPv6 Address	: fe80::250:7fff:feef:d6a0/64 (Link)

Wireless	
MAC Address	: 00:50:7F:CF:D6:A0
SSID	: DrayTek
Channel	: 6
IPv6 Address	: fe80::250:7fff:feef:d6a0/64 (Link)

WAN 1	
Connected Type	: DHCP
Link Status	: Disconnected
MAC Address	: 00:50:7F:CF:D6:A1
IP Address	: ---
IP Mask	: ---
Default Gateway	: ---
Primary DNS	: ---
Secondary DNS	: ---
IPv6 Address	: fe80::250:7fff:feef:d6a0/64 (Link)

4. There are four operation modes for you to choose. Simply click any one of them and click **Apply**. The system will make a connection automatically.

Quick Start Wizard

Welcome to the Quick Start Wizard!

The next steps will guide you through a basic setup of the device.
If you want more advanced setup you should consider setting the device up manually.

- Step 1: Setup the Password
- Step 2: Setup the Time and Date
- Step 3: Setup the Internet connection (WAN)
- Step 4: Setup the Wireless (Wi-Fi)
- Step 5: Save the configuration

< Back

Next >

Finish

Cancel

5. The first screen of **Quick Start Wizard** is entering login account and password. After typing the password, please click **Next**.

Quick Start Wizard

Administration Password

Account

admin

Password

•••••

< Back

Next >

Finish

Cancel

6. On the next page as shown below, please select the Time Zone for the router installed and specify the NTP server(s). Then click **Next** for next step.

Quick Start Wizard

Time and Date

Time Information
Current System Time: Wed Jul 2 17:15:25 GMT 2014 [Inquire Time](#)

Time Setting
 Use Browser Time
 Use NTP Client
Time Zone: (GMT-11:00) Midway Island, Samoa
NTP Server: [Use Default](#)
NTP synchronization: 30 sec

[< Back](#) [Next >](#) [Finish](#) [Cancel](#)

7. On the next page as shown below, please select the appropriate **Access Mode** according to the information from your ISP. There are several types offered in this page. Each access mode will bring out different web page.

Quick Start Wizard

Internet Access - WAN 1

Access Mode: DHCP

Dynamic IP(DHCP Client)
Router Name: VigorFly210

[< Back](#) [Next >](#) [Finish](#) [Cancel](#)

8. Here we choose **4G USB Modem** as an example. According to the location of the device installed, choose the service provider from the drop down list.

Quick Start Wizard

Internet Access - WAN 1

Access Mode ▼

4G USB Modem(DHCP Mode)

Service Provider ▼

Note : [Support list table](#)

Note: For other types, please refer to User's Guide for detailed information.

9. You will get different web settings according to the service provider specified. Here, **Nicaragua (YOTA)** is selected. Therefore, you have to enter Username, Password and specify Cipher Suite respectively. Contact your dealer/service provide to obtain the correct information. Later, click **Next**.

Quick Start Wizard

Internet Access - WAN 1

Access Mode ▼

4G USB Modem(DHCP Mode)

Service Provider ▼ (WiMAX:Yota Jingle WU217/Yota One/Seowon SWU-500E)

Note : [Support list table](#)

10. On the next page as shown below, please select the appropriate connection type according to the information from your ISP.

Quick Start Wizard

Internet Access - WAN 2

Access Mode	DHCP <input type="button" value="v"/>
Dynamic IP(DHCP Client)	
Router Name	VigorFly210
Note : WAN2 is used for backup only.	

Note: WAN 2 is only used for backup WAN1 interface.

11. Here we take DHCP type as an example. It is not necessary for you to type any IP address manually. Simply choose this type and the system will obtain the IP address automatically from the DHCP server.
12. In this page, select a proper security mode and set the required value. Click **Next**.

Quick Start Wizard

Wireless System Configuration

Enable Wireless LAN	<input checked="" type="checkbox"/>
Hide SSID	<input type="checkbox"/>
SSID	DrayTek
Wireless Security Settings	
Mode	Mixed(WPA+WPA2)/PSK <input type="button" value="v"/>
WPA	
WPA Algorithms	<input checked="" type="radio"/> TKIP <input type="radio"/> AES <input type="radio"/> TKIP/AES
Pass Phrase	●●●●●●●●
Key Renewal Interval	3600 seconds

Default Pre-Shared Key (PSK) is provided and stated on the label pasted on the side of the router. For the wireless client who wants to access into Internet through such router, please input the default PSK value for connection.

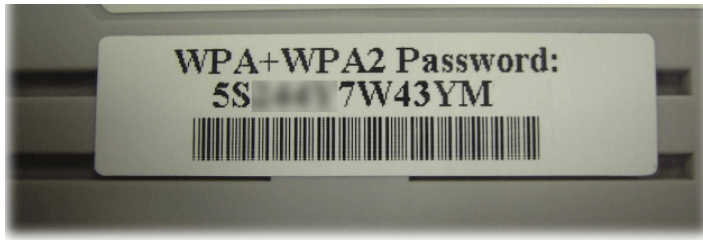

13. Now you can see the following screen. It indicates that the setup is complete. Different types of connection modes will have different summary. Click **Finish** and then restart the router. Afterward, you will enjoy surfing on the Internet.

Quick Start Wizard

Vigor Wizard Setup is now finished!

Press Finish button to save and finish the wizard setup.
Note that the configuration process takes a few seconds to complete.

Contacting DrayTek

If the router still cannot work correctly after trying many efforts, please contact DrayTek for further help right away. For any questions, please feel free to send e-mail to support@draytek.com.